

PAINLESS[®]

PERFORMANCE PRODUCTS



Wire Harness Installation Instructions

For Installing Harness Numbers:

**10413: 25 Circuit - Pro Series - GM Keyed Column -
Bulkhead Firewall Pass-Through**

**10414: 25 Circuit - Pro Series - Key in Dash - Bulkhead
Firewall Pass-Through**

Manual #90631

Painless Performance Products recommends you, the installer, read this installation manual from front to back before installing this harness.

Painless Performance Products, LLC
2501 Ludelle St.
Fort Worth, TX 76105-1036
PHONE: 800-423-9696 FAX: 817-244-4024
EMAIL: painless@painlessperformance.com

If you have any questions concerning the installation of this harness, feel free to call Painless Performance Products' Tech Line at 1-800-423-9696. The Tech Line can be reached from 8 A.M. to 5 P.M. central time, Monday through Thursday, and 8 A.M. to 4:30 P.M. on Fridays.

We have attempted to provide you with as accurate instructions as possible and are always concerned about corrections or improvements that can be made. If you have found any issues or omissions, or simply have comments or suggestions concerning these instructions, please write us at the above address, send us a fax at (817) 244-4024, or email us at painless@painlessperformance.com. We sincerely appreciate your business.

Painless Performance Products, LLC shall in no event be liable in contract or tort (including negligence) for special, indirect, incidental, or consequential damages, such as but not limited to, loss of property damage, or any other damages, costs or expenses which might be claimed as the result of the use or failure of the goods sold hereby, except only the cost of repair or replacement.

CAUTION: BEFORE THE REMOVAL OF YOUR ORIGINAL HARNESS AND/OR THE INSTALL OF YOUR NEW PAINLESS HARNESS, DISCONNECT THE POWER FROM YOUR VEHICLE BY REMOVING THE NEGATIVE OR POSITIVE BATTERY CABLE FROM THE BATTERY.

- A full-color copy of these instructions can be found online at:

<http://www.painlessperformance.com/manuals/10413.pdf>

OR

<http://www.painlessperformance.com/manuals/10414.pdf>

- If your vehicle has an existing harness, you will want to retain it for the possible re-use of various pigtails and connector housing particular to your application. During the removal process, avoid making any unnecessary cuts.
- This harness is universal. This means most/all ends are left open to allow you to cut each wire to length and install/make the appropriate connection. The small parts package and the bag kits with terminals and connectors included with the harness will enable you to make connections.
- Only printed wires have a 900-series number. These 900-series numbers are used to identify various wires and circuits in the wiring diagrams that are a part of these instructions.

If there are unused or unconnected wires, they will need to have their ends terminated with an insulated terminal or electrical tape. Doing so will prevent the wires from shorting and causing harness failure or fire.

TABLE OF CONTENTS

<u>PAGE #</u>	<u>SECTION</u>
1	<u>INTRODUCTION</u>
2	<u>CONTENTS</u>
3	SMALL PARTS
4	<u>TOOLS NEEDED</u>
5	<u>TO REMOVE A TERMINAL</u>
6	<u>INSTALLING FACTORY STYLE TERMINALS</u>
7	<u>GROUNDS</u>
8	WHY ARE CLEAN GROUNDS IMPORTANT?
10	<u>FUSE BLOCK</u>
10	HORN RELAY
10	FLASHERS
11	FUSE IDENTIFICATION
12	ACCESSORY PORTS
13	RELAYS & SWITCHES
15	<u>OLD FACTORY HARNESS REMOVAL</u>
16	<u>PRE-INSTALLATION GUIDELINES</u>
19	<u>FUSE BLOCK MOUNTING</u>
20	ENGINE HARNESS
21	ENGINE BULKHEAD
22	BULKHEAD PIN OUT
23	ENGINE BULKHEAD MOUNTING
24	BEFORE ROUTING THE ENGINE HARNESS
25	<u>HARNESS ROUTING</u>
25	ENGINE HARNESS
26	INTERIOR HARNESS
27	<u>ENGINE HARNESS</u>
27	<u>FRONT LIGHTING SECTION</u>
28	LEFT / DRIVER SIDE HEADLIGHT
30	LEFT PARK / SIDE MARKER LIGHT
32	LEFT TURN / PARK LIGHT
34	HORN
35	RIGHT TURN / PARK LIGHT & HEADLIGHT
35	GROUND
35	FAN RELAY
39	<u>WIPER MOTOR SECTION</u>
39	WIPER MOTOR
40	WASHER PUMP
41	<u>ENGINE SECTION</u>
42	BRAKE WARN SWITCH
43	COOLANT TEMP SENSOR
44	OIL PRESSURE SENSOR
45	ELECTRIC CHOKE
46	Turbo 400 Transmission
47	<u>COIL / IGN. SECTION</u>
48	Tachometer

Continued...

TABLE OF CONTENTS

<u>PAGE #</u>	<u>SECTION</u>
51	<u>START / CHARGE SECTION</u>
51	ALTERNATOR
53	CHARGE INDICATOR LIGHT
55	GM SI SERIES ALTERNATORS
56	GM CS-130 SERIES ALTERNATORS
58	GM CS-130D SERIES ALTERNATORS
60	GM EXTERNALLY REGULATED ALTERNATOR
61	MIDI FUSE
62	STARTER SOLENOID
63	4L60e/4L80e Switch
65	<u>INTERIOR HARNESS</u>
66	<u>DIMMER SWITCH</u>
68	<u>DRIVER COURTESY LIGHT SECTION</u>
68	DRIVER DOOR JAMB SWITCH
69	DRIVER COURTESY LIGHT
71	<u>HEADLIGHT SWITCH</u>
73	GM HEADLIGHT SWITCH
74	PAINLESS UNIVERSAL HEADLIGHT SWITCHES
75	<u>WIPER SWITCH</u>
76	<u>BRAKE SWITCH</u>
77	<u>TURN SIGNAL SWITCH</u>
79	GM COLUMNS / AFTERMARKET GM STYLE COLUMNS
82	<u>IGNITION SWITCH</u>
83	GM COLUMN MOUNTED (PRE-TERMINATED ON 10403)
84	GM DASH MOUNTED (10404)
85	PAINLESS UNIVERSAL IGN. SWITCH - #80153
86	<u>EMERGENCY BRAKE SWITCH</u>
87	<u>REVERSE SWITCH</u>
89	<u>NEUTRAL SAFETY / CLUTCH SWITCH</u>
90	<u>INSTRUMENT PANEL</u>
92	FACTORY PRINTED CIRCUIT GAUGES
93	SEPARATE HARNESS- PAINLESS #30301 & 30302
94	HARD WIRING
99	<u>RADIO & ACCESSORIES</u>
100	RADIO
101	ACCESSORY SECTION
102	Cigarette Lighter / Power Port
102	Clock
102	Additional Wires
103	Power Windows & Power Locks
104	<u>PASSENGER COURTESY LIGHT SECTION</u>
105	PASSENGER COURTESY LIGHT
106	GLOVE BOX SWITCH
107	PASSENGER SIDE DOOR JAMB SWITCH
108	<u>TAIL SECTION</u>

Continued...

TABLE OF CONTENTS

<u>PAGE #</u>	<u>SECTION</u>
108	DOME LIGHT
109	AFTERMARKET AMPLIFIER
109	LEFT SIDE MARKER LIGHT
110	LEFT TURN / BRAKE LIGHTS
111	TAILLIGHTS
112	REVERSE LIGHT
113	FUEL SENDING UNIT
114	FUEL PUMP
115	LICENSE PLATE LIGHT
115	RIGHT TURN/ BRAKE/ REVERSE/ MARKER LIGHTS
116	<u>GROUND</u>
119	<u>TESTING THE SYSTEM</u>
120	<u>WIRE INDEX</u>

SCHEMATICS

<u>PAGE #</u>	<u>SECTION</u>
13	12 VOLT SOURCE ACTIVATION
14	GROUND ACTIVATION
14	FAN RELAY GROUND ACTIVATION
31	SIDE MARKER LIGHTS
36	FAN RELAY 12 VOLT SOURCE ACTIVATION
36	FAN RELAY GROUND ACTIVATION
37	FRONT LIGHTING SECTION
38	FRONT GROUND SCHEMATIC
40	WIPER SECTION
41	ENGINE SECTION SCHEMATIC
46	CHOKE & TH400 TRANSMISSION
49	COIL CONNECTIONS (NO BALLAST RESISTOR)
49	BALLAST RESISTOR CONNECTIONS
50	HEI COIL ON CAP CONNECTIONS
50	MSD IGNITION CONNECTIONS
54	CHARGE INDICATOR LIGHT
55	10-SI ALTERNATOR
57	CS-130 ALTERNATOR
59	CS-130D ALTERNATOR
60	EXTERNAL VOLTAGE REGULATOR
63	4L60e/4L80e NSS/REVERSE SWITCH
64	CHARGE / BATTERY POWER
67	HEADLIGHT DIMMER SWITCH
70	DOME/COURTESY LIGHT
72	HEADLIGHT SWITCH & DIMMER SWITCH
73	EARLY STYLE GM HEADLIGHT SWITCH (also PAINLESS #80152)
73	LATER STYLE GM HEADLIGHT SWITCH
74	PAINLESS HEADLIGHT SWITCH #80151
74	PAINLESS HEADLIGHT SWITCH #80154
81	TURN SIGNAL SWITCH & BRAKE SWITCH
83	COLUMN MOUNTED GM IGNITION SWITCH (10413)
84	MID TO LATE 60s GM DASH MOUNTED IGNITION SWITCH
84	'55 - '57 CHEVY IGNITION SWITCH PINOUT
85	PAINLESS UNIVERSAL IGNITION SWITCH #80153
94	POWERING AFTERMARKET GAUGES (SPLICING)
94	POWERING AFTERMARKET GAUGES (CHAINING/JUMPING)
95	GROUNDING AFTERMARKET GAUGES (SPLICING)
95	GROUNDING AFTERMARKET GAUGES (CHAINING/JUMPING)
96	AFTERMARKET GAUGE LIGHT POWER (SPLICING)
96	AFTERMARKET GAUGE LIGHT POWER (CHAINING/JUMPING)
97	AFTERMARKET GAUGE SENDER WIRES
98	INSTRUMENT PANEL
99	RADIO & ACCESSORY SECTION
116	TAIL SECTION GROUND
117	TAIL SECTION W/ INTEGRATED TURN/BRAKE LIGHTS
118	TAIL SECTION W/ SEPARATE TURN/BRAKE LIGHTS
126	BULKHEAD TEMPLATE FOR VEHICLES WITH NO BULKHEAD HOLE

INTRODUCTION

Thank you for your purchase of a Painless Performance Products PRO Series Harness. This is a customizable harness; therefore, we suggest you retain your original harness for any unique plugs or connectors you may need while installing your new harness.

The fuse block is pre-terminated, and the proper fuses for each circuit are pre-installed. All wires are colored based on GM color codes. Also, each wire is marked with a 900-series wire number, what section the wire is in, and the wire's function. These 900-series numbers are assigned by Painless and do not correspond to any circuit numbers found on any factory wiring schematics. A Wire Index is located on [pages 120 – 124](#) and provides a quick reference guide for the individual wires of this harness. The Wire Index identifies the gauge, color, what is printed on the wire, and point of origin for each wire.

During this manual, you will notice wires with a slash (Ex. **BLUE/WHITE**). This indicates a wire with a stripe. The first color listed is the main wire color, and the second color will reference the stripe color. Therefore, the **BLUE/WHITE** example will be a **BLUE** wire with a **WHITE** Stripe.

Do not let the length of this instruction manual intimidate you. Much of the information contained in this manual is helpful information about each wire, where the wire comes from, where it goes, why a component needs it, etc. In many cases, there are multiple schematics as well as alternate connection options for the same wire/connection point due to this being a customizable harness. You will find that the actual install portions of this manual are straightforward and easy to follow.

Individual components and sections are tied together for easy routing of the harness. GM color-coded wires with printed circuit numbers and descriptions on each, along with the schematic diagrams found throughout this manual, will help you identify the different circuits during installation and later on if additions to the overall system are necessary.

As you read through this installation manual, before installing your new harness, you will find blank areas titled **NOTES** in each section and the back of the manual. You may find these sections beneficial for taking notes, listing components you are connecting to on your vehicle and the factory or manufacturer wires that are coming from the component. You can then use the text in the manual and the wire index in the back of the manual to identify the wire and circuit number in the Painless harness that will connect to that requirement. For example, a turn signal switch for a 1966 Impala:

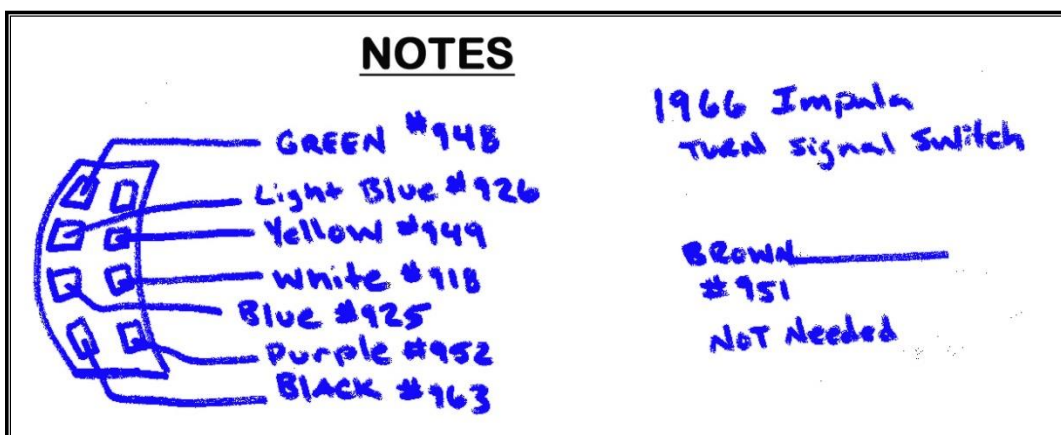

CONTENTS

Refer to the **Contents Picture** (below) to take inventory of this kit. See that you have everything you are intended to have in this kit. If you find that anything is missing or damaged, please contact the dealer where you obtained the kit or Painless Performance at (800) 423-9696.

The Pro Series harnesses come with two main options/differences. Option one is going to be pre-terminated for a 1968+ GM turn signal switch and pre-terminated with connectors installed for GM column mounted ignition switch, this is **part #10413**. Option two contains all the same wiring but will not be pre-terminated for a GM Column, this is **part #10414**.

The Painless Wire Harness Kits 10413 and 10414 contains the following:

- Pre-terminated fuse block and interior harness.
- Bulkhead and engine harness.
- (2) Ground Sub harnesses: (1) Front-Lighting Ground (1) Rear Lighting Ground
- (1) 6-gauge charge wire
- (2) Small Parts Kits
- (4) Parts bags: Alternator bag, uninsulated terminal bag, heat-shrink bag, and a larger miscellaneous parts bag that includes zip-ties, connectors, and other parts.



SMALL PARTS

This Painless harness includes several parts kits containing a variety of terminals, fuses, and screws. Many of the terminals are non-insulated and require heat-shrink to be applied after the terminal is properly crimped. Heat-shrink is supplied with this kit.

These non-insulated terminals allow you to keep a cleaner, more factory look; colored insulated terminals can look out of place. When crimping these terminals, take notice of the split in the terminal. Always make sure the split in these non-insulated terminals is facing the groove.

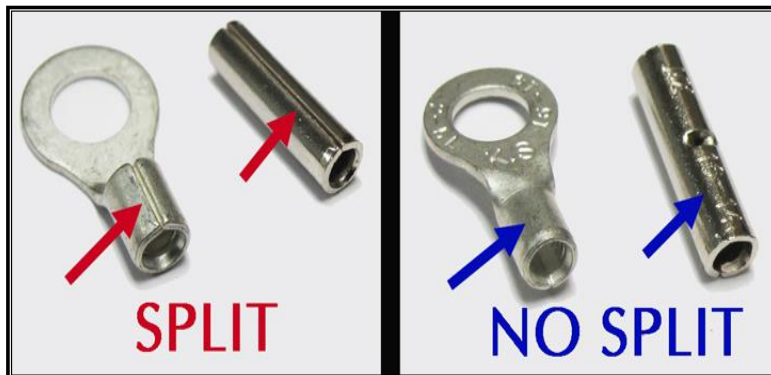

“Umbrella” style zip-tie clips have been provided for you to attach the Painless harness to the inner fender, core support, and/or frame. These zip-tie clips fit into $\frac{1}{4}$ ” holes left behind by factory plastic retainer loops or those created with a drill by the installer.



TOOLS NEEDED

In addition to your regular hand tools, you will need, at least, the following tools:

- **Wire Crimping and Stripping Tools:**

The style of hand crimpers seen to the right are available at just about any local auto parts store, home improvement store, or can also be purchased online. You need this style of crimper to crimp many of the terminals included in the small parts kits.

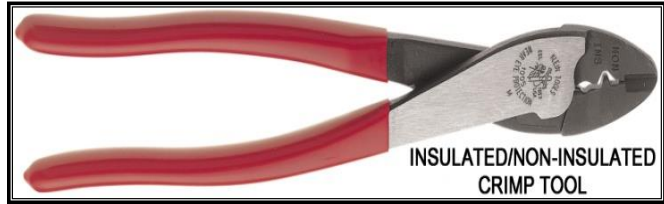

Another style of crimpers is "Jaw" Crimpers or "Roll-Over" Crimpers. These crimpers will crimp factory style, non-insulated terminals. These types of terminals are provided in the kit for connecting to an HEI distributor, headlights, and factory-style alternator. Painless offers Roll-Over Crimpers, such as those seen to the right, under **Painless part #70900**.

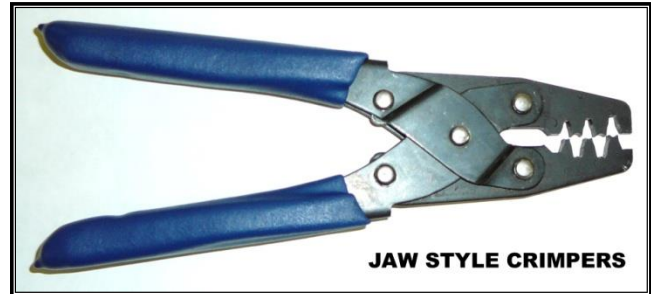

A hammer crimper, seen to the right, will be useful for crimping ends onto large gauge wires. These crimpers will crimp large, non-insulated terminals, and can be purchased relatively cheaply from most auto parts stores and online.



A good set of wire strippers is required to strip wire properly. This style of wire stripper is ideal for this harness install because of its ability to properly strip wire gauges 10 to 20. These are available from just about any local auto part store, electrical supply shop, home improvement store, or can be purchased online.

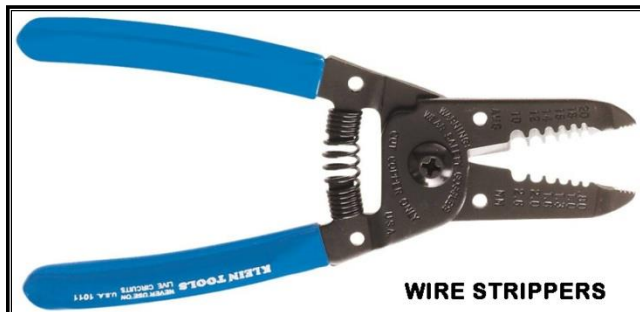

- **Volt/Ohm Meter:**

A Volt/Ohm meter is always a good tool to have on hand when installing any type of electrical components in a vehicle. Most basic units provide the two functions required to diagnose electrical issues seen during a harness install. These two functions are the ability to read DC Voltage and electrical continuity or Ohms. They can be purchased from any home improvement store, local hardware store, electrical supply shop, and online.



- **Electric Drill & Drill Bits:**

A drill and bits are needed to mount the MIDI fuse holder and the fuse block. Additionally, a 1/4" drill bit is required to mount the "umbrella" style zip-ties provided with the kit.

- **Heat Gun:**

Especially useful to shrink the heat-shrinkable terminals found in the parts kit.



- **Small (10 amp or less) Battery Charger**

See **TESTING THE SYSTEM** located on [page 119](#).

- **Factory Wire Schematic**

This is not necessary; however, having one handy is good practice with any electrical job.

TO REMOVE A TERMINAL



- Notice the locking tang that holds the terminal in the connector. Locate the tang access slot on the terminal end of the connector. Push a paper clip, stiff wire, or a small flat head screwdriver into the slot to depress the locking tang on the terminal.
- Once depressed, pull the harness wire from the connector. Do not pull too hard or you could pull the wire out of the terminal; this leaves the terminal stuck in the connector.

INSTALLING FACTORY STYLE TERMINALS

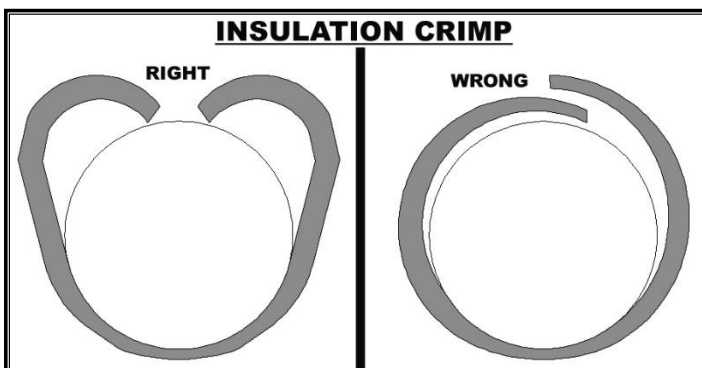
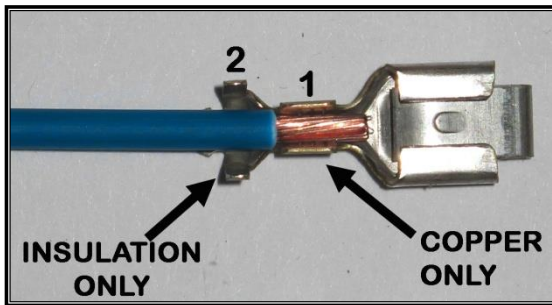

In the parts kit, you will see different uninsulated male and female terminals. These terminals are for factory-style connections and require rollover crimpers.

- Strip about $\frac{1}{4}$ " of insulation off the wire.
- Insert the wire into the terminal. There are two terminal straps on the terminal. For instructional purposes, we will label them 1 and 2. Strap 1 crimps the exposed copper strands of the wire, while strap 2 crimps the wire insulation. Make your strip length long enough to ensure only copper strands are crimped by Strap 1 but short enough that only insulation is crimped by Strap 2. The photo to the left best demonstrates this.
- Using the appropriate jaw on the crimpers, crimp Strap 1. The appropriate jaw depends on the wire gauge as well as the terminal stiffness. If you are unsure which jaw to use, you can always start with the biggest and work your way down until you get a tight crimp.
- With Strap 1 crimped, move onto crimping the insulation strap: Strap 2. Place Strap 2 into the appropriate jaw of the crimpers. This jaw will be larger than the one used to crimp the first strap. Crimp down on Strap 2. Make sure the strap folds down into the wire and does not overlap itself. Refer to the drawing to the left. Overlapping could cause problems with the terminal fitting into the factory connector.

GROUNDS

Throughout this instruction manual, and when looking at the Painless harness, you will see the word GROUND. Maybe you have seen the ground symbol on wiring diagrams before? What exactly is a ground and why do you need it?

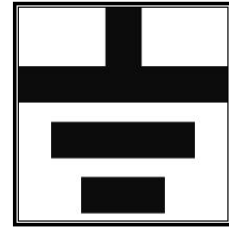

You have probably noticed the large cable coming from the negative side of your battery going down to the frame or the engine. This cable allows voltage to get back to the battery through the metal of the frame and all the other metal pieces bolted to the frame. It is also important to have ground cables going from the frame to the engine and from the frame to the body.

A ground is simply the common path electrical current follows back to the battery. A ground, or chassis ground as it is often called, is any bare metal surface found on the vehicle which is in turn connected back to the frame/negative side of the battery through mounting points and ground straps. Grounds are needed for the electrical current to complete the circuit.

There are two ways components are grounded in vehicles: through mounting and a wired connection.

Some grounds are supplied through mounting of the metal housings in which bulbs are installed, like turn signal or taillight housings. Components with plastic housings or non-conductive housings, like headlights which are glass, get their grounds through wires from the chassis harness.

Make sure all mounting points are clean by removing any dirt, corrosion, and/or paint. This includes light housings that ground through mounting them and the harness ground wire connection point. This is especially important for cars that have recently been painted as paint build-up will cause grounding issues. 80 grit or courser sandpaper should be all that is needed to thoroughly clean grounding points.

To help avoid grounding problems, this kit provides ground harnesses for the front and rear lighting sections. The front lighting ground harness covers the headlights, front turn signals, and park lights. The rear ground harness covers the taillights, rear turn signals, marker lights, reverse lights, and license plate light. Three braided ground straps have also been supplied to allow grounding the body of the vehicle to the frame. Good locations for these straps are the core support to the frame, firewall/floorboard to the frame, and trunk/tail panel to the frame. Self-tapping screws and star washers have also been provided in the parts bag to make installation easier.

GROUND STRAPS

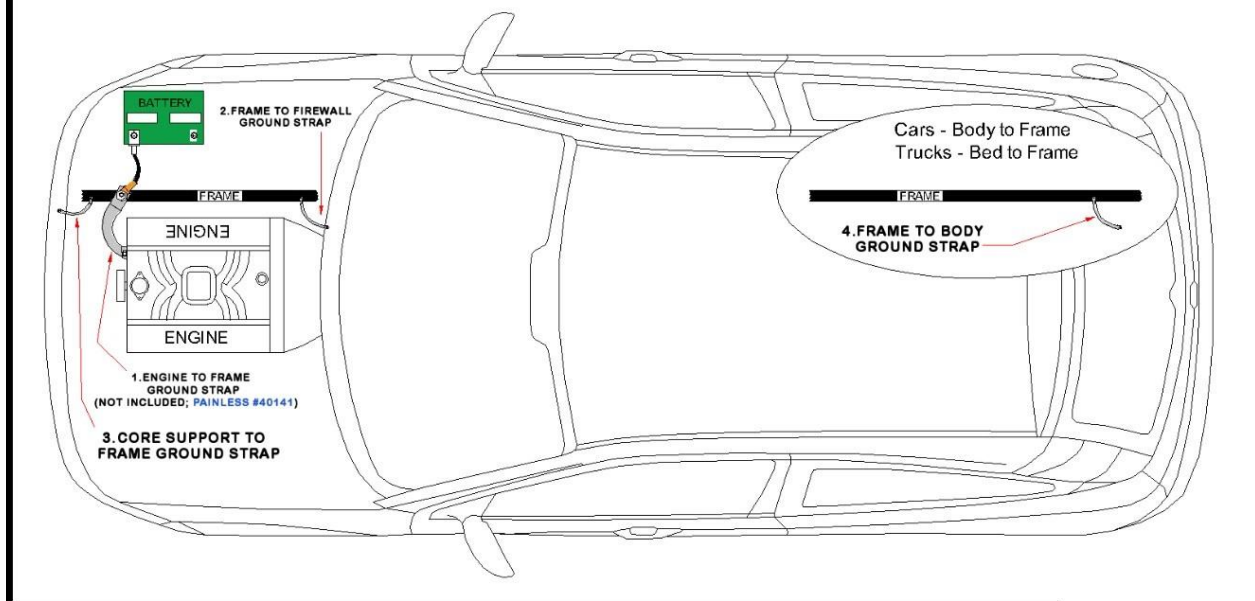

WHY ARE CLEAN GROUNDS IMPORTANT?

As an example, we will use a front turn signal that also functions as a park light. Follow the red line from right to left in the diagram below. This red line indicates the path the electrical current takes when everything is properly grounded. The diagram on the next page represents when the ground is bad. Notice which bulbs illuminate when good and bad grounds are present.

In our park light example with a good ground source, current travels from the headlight switch to the park light bulb element. Since the bulb is properly grounded, current passes cleanly through the bulb causing it to illuminate, and the current exits the bulb through the ground source back to the battery. The ground allows everything to work properly without any issues.

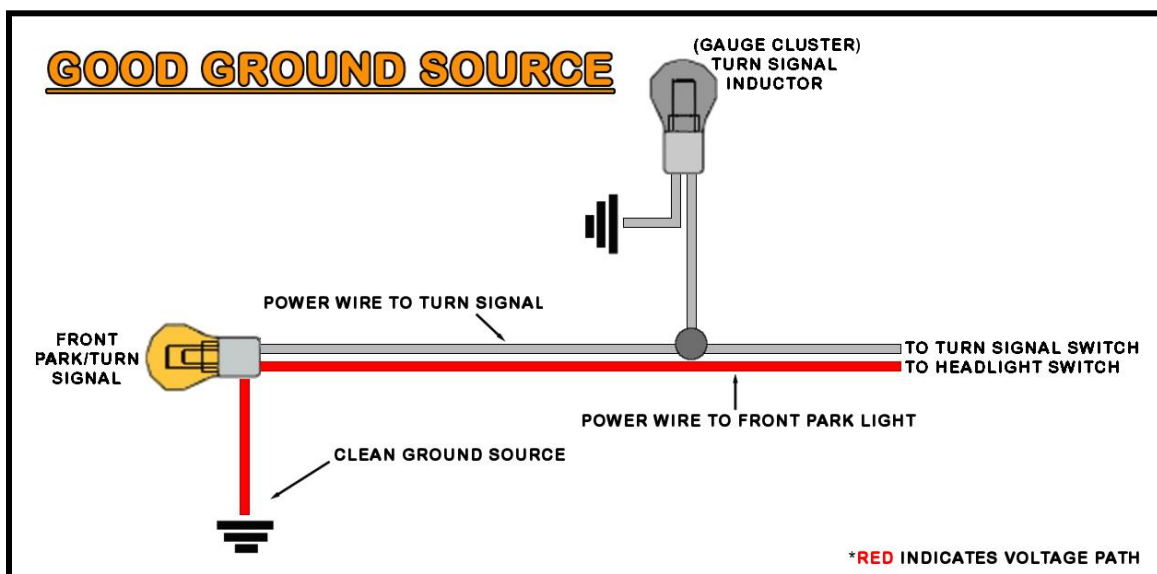

When a ground is not connected properly or is contaminated with dirt, corrosion, or paint, the current will then find the easiest path to ground. This is represented in the diagram below.

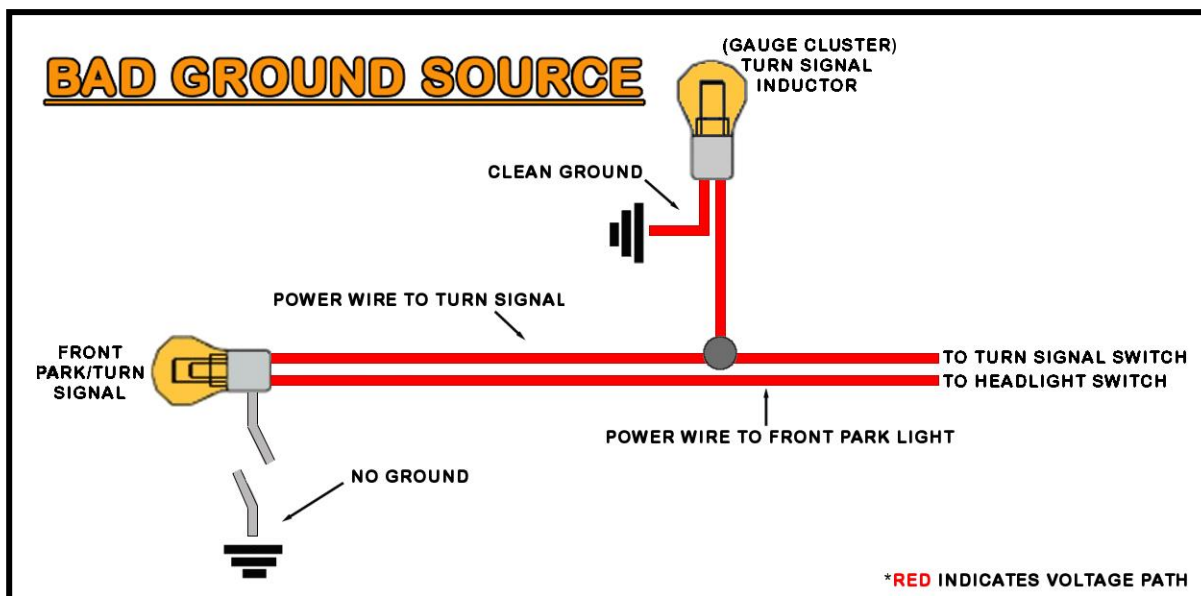

Current travels from the headlight switch to the park light bulb element. However, there is no ground at the bulb. Since the ground it normally uses is not there, the current finds another path to ground and back to the battery. When this happens, things that should not have power receive power coming from the park light bulb. Since the turn signal wire also goes to the bulb, the current will travel out of the bulb through the turn signal wire. Notice this bad ground at the front park/turn signal bulb can cause issues on the interior of the vehicle at the turn signal indicator on the dash. In this case, the turn signal indicator light is illuminated when it should not be. Also, since this one power source which was only supposed to power 1 bulb is now powering 2 bulbs, both bulbs may be dimmer than they would be if everything were grounded properly. This is one of the problems with diagnosing a bad ground: they can cause issues throughout the entire vehicle.

FUSE BLOCK

Your Painless harness contains a pre-terminated fuse block that uses modern ATC blade style fuses. There are 18 fuses controlling 25 circuits. **These fuses each contain an LED that will illuminate when a fuse blows.** This fuse block allows the convenience of having both flashers (turn signal and hazard), as well as the horn relay, all mounted in one location.

HORN RELAY

On the fuse block, you will find a horn relay that replaces the factory core support/firewall mounted horn relay found on many older vehicles. The fuse block mounted horn relay uses a standard 30-amp SPST relay and is ground activated from a wire in the Turn Signal Switch group of wires. Replacement relays for the horn relay can be found at any auto parts store or by ordering **Painless part number #80131**.

FLASHERS

The two flashers simply switch power on and off going to the turn signal switch and hazard switch. The flasher on the right is the hazard flasher. The flasher on the left is the turn flasher.

How a flasher functions is simple. Power is switched off and on according to heat built-in the resistance wire inside the flasher. As soon as the current is drawn through the flasher, as when the turn signal or hazard switch is activated, the resistance wire heats up and contacts the output side of the flasher. This contact passes power through the flasher, into the switch and to the turn signal lamp(s). Once this contact is made, the resistance wire is no longer resisting any current, so it begins to cool; this cooling causes the flasher to lose contact. This loss of contact means that there is no longer any current going to the switch, causing the turn signal light to turn off. Once contact is lost, the resistance wire begins heating up and the entire process starts over again until the turn signal switch or hazard switch is disengaged.

Some LED turn signals do not draw enough current to activate a typical thermal flasher. If you are using LED turn signals, and your turn signals do not work properly and you are certain everything is connected properly, a no-load flasher will be required (**Painless part number #80230**).

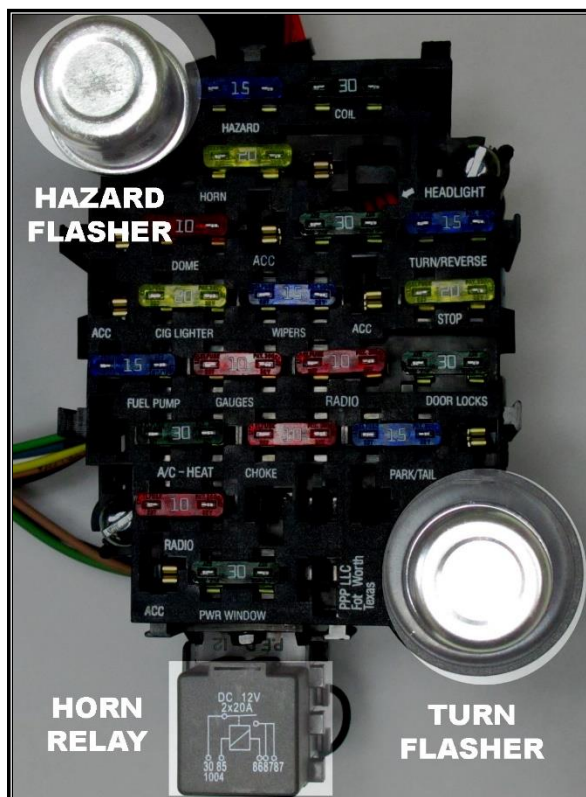

FUSE IDENTIFICATION

The following two diagrams and information will detail each fuse and which components/circuits each fuse powers.

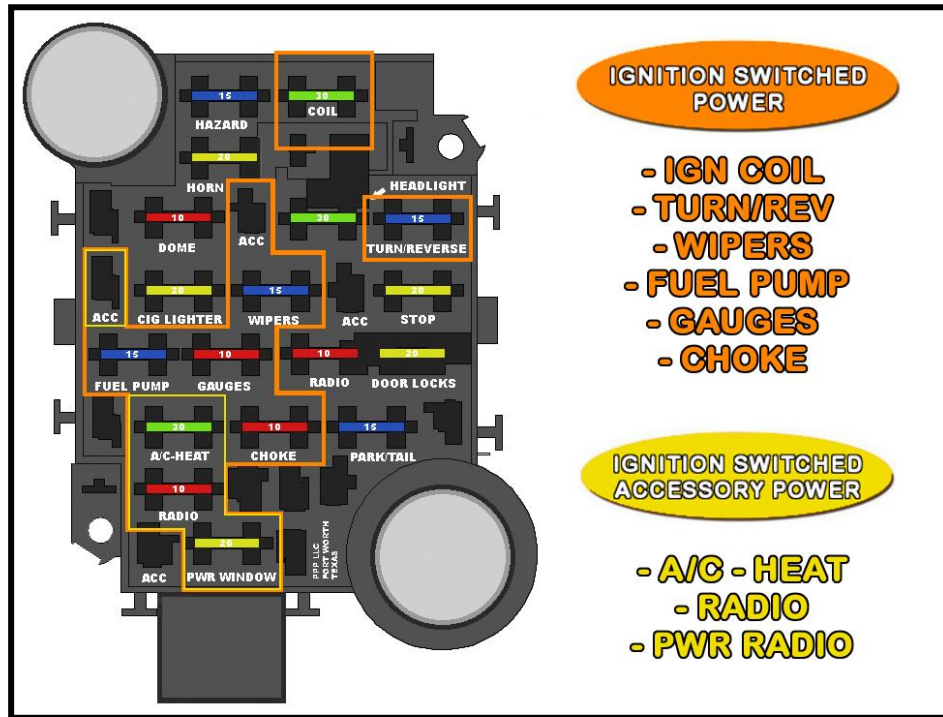

The drawing above shows all the switched ignition fuses. These fuses are powered by wires coming from the ignition switch (wires #931, #932, and #933) and receive power depending on what position the ignition switch is in. **None of these fuses should have power when the ignition is in the OFF position.** The **Ignition Switch Section** beginning on [page 82](#) of this manual will go into further detail about power supplied to these fuses.

The drawing below shows all the battery power fuses. These fuses are powered by a wire that comes from the large power splice, seen on [page 64](#). The battery power fuses always have power.

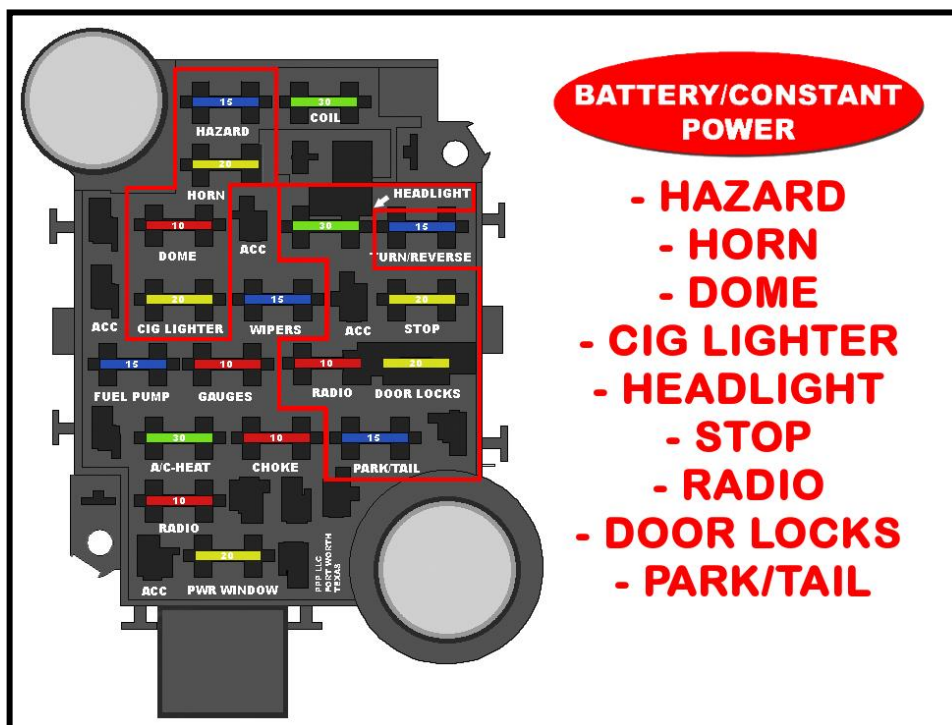

ACCESSORY PORTS

You will notice 4 single, open power ports on the front of the fuse block. These ports give you access to constant power and switched power for extra circuits you may need now or in the future.

Terminals and connectors, seen to the right, are provided in the parts kit to allow you to tap into these extra sources. Since each of these ports is keyed differently, simply shave the key on the connector off to allow connection into any port. The power ports marked below in with a dot are un-fused power sources and must have an inline fuse, no larger than 10 amps, installed before being routed to a component needing power. Anything needing more than 10 amps will need to have a relay installed. See relay wiring and activation on the next page for details.

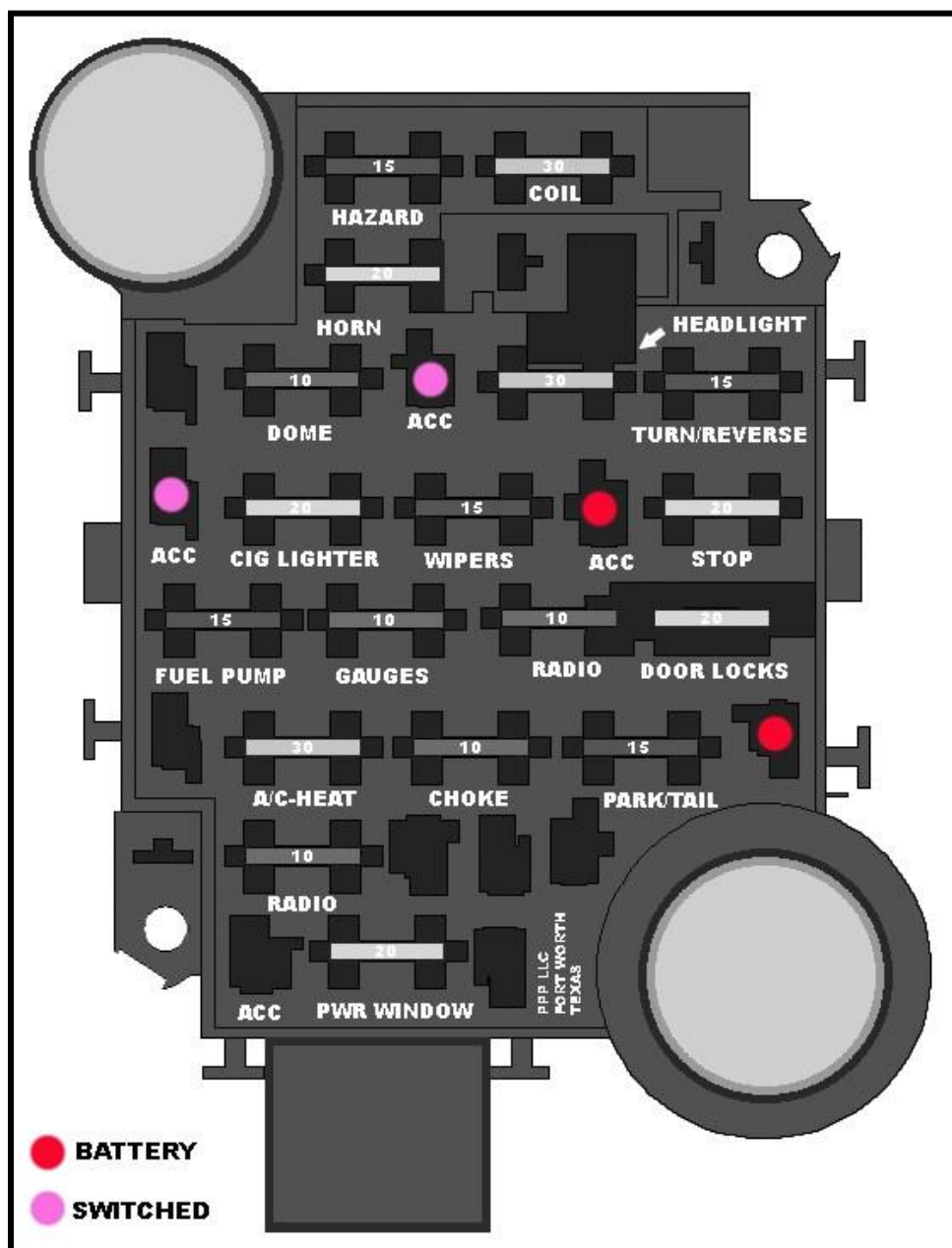

RELAYS & SWITCHES

All ACCESSORY wires found in this harness can support up to 15 amps alone. Components requiring more amperage will need to be connected to a relay. The amount of amperage needed by the component will determine the size of the relay and circuit breaker needed. An ACCESSORY wire can be used as a 12-volt activation source or 12-volt source for ground activation in these circumstances. *Take a look at [Painless Relay Banks \(part #'s 30107 & 30108\)](#) or [Painless Single Relays \(like part #'s 80130 & 80131\)](#) to fill your relay needs at www.painlessperformance.com/webcatalog/relay.*

A 12-volt activated relay is constantly grounded. As the name implies, the relay sends power from the output side of the relay to the component being powered when 12 volts is applied. The 12-volt source can be wired directly to the relay or interrupted by a switch, as shown in the *12 VOLT SOURCE ACTIVATION* drawing.

Wiring directly to the relay, as indicated by the dashed line, would be used in the case of wiring a water pump relay or any other high amperage component you would want to run continuously while the key is in the on position. In these cases, make certain the 12-volt wire you are using is an Ignition Switched 12-volt wire and not a battery constant hot.

The 12-volt activation wire can also be wired to a switch to offer the user OFF/ON capabilities. In these situations, a constant battery power source would be used. This would allow a component to be turned OFF or ON without the key in the ON position. However, unless a lighted switch is being used, a ground activated relay may work better to avoid running power through the switch.

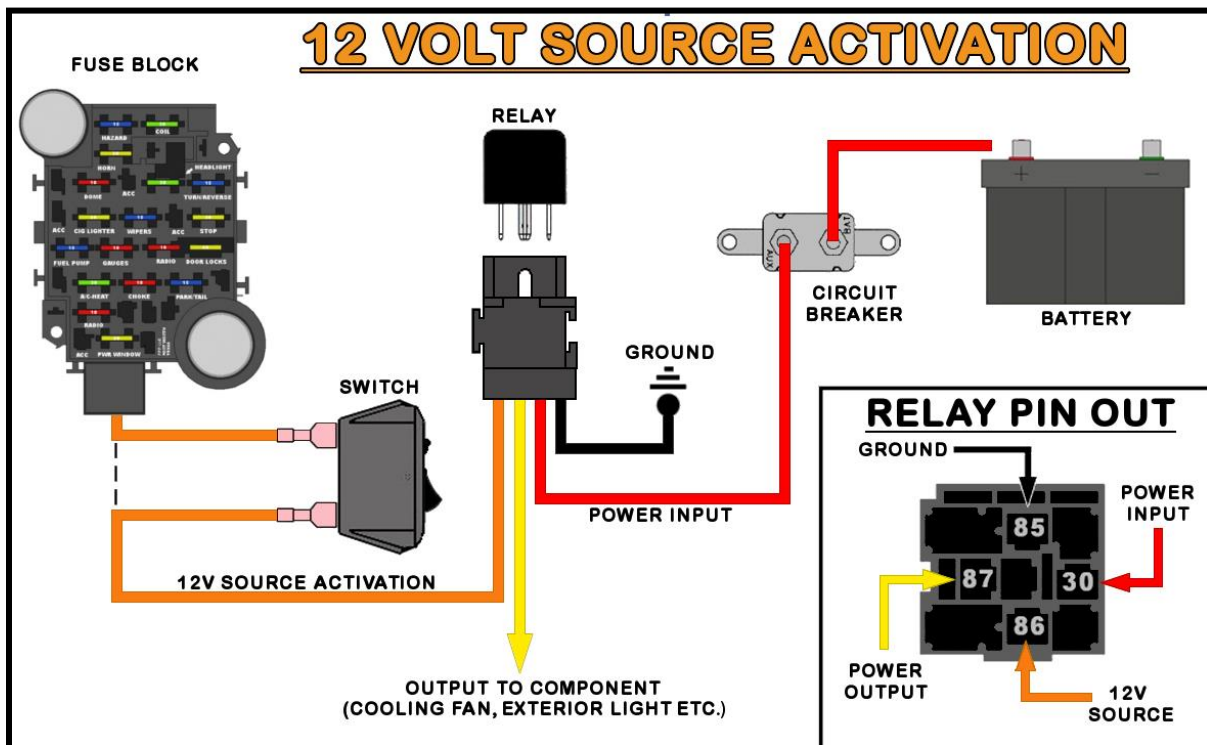

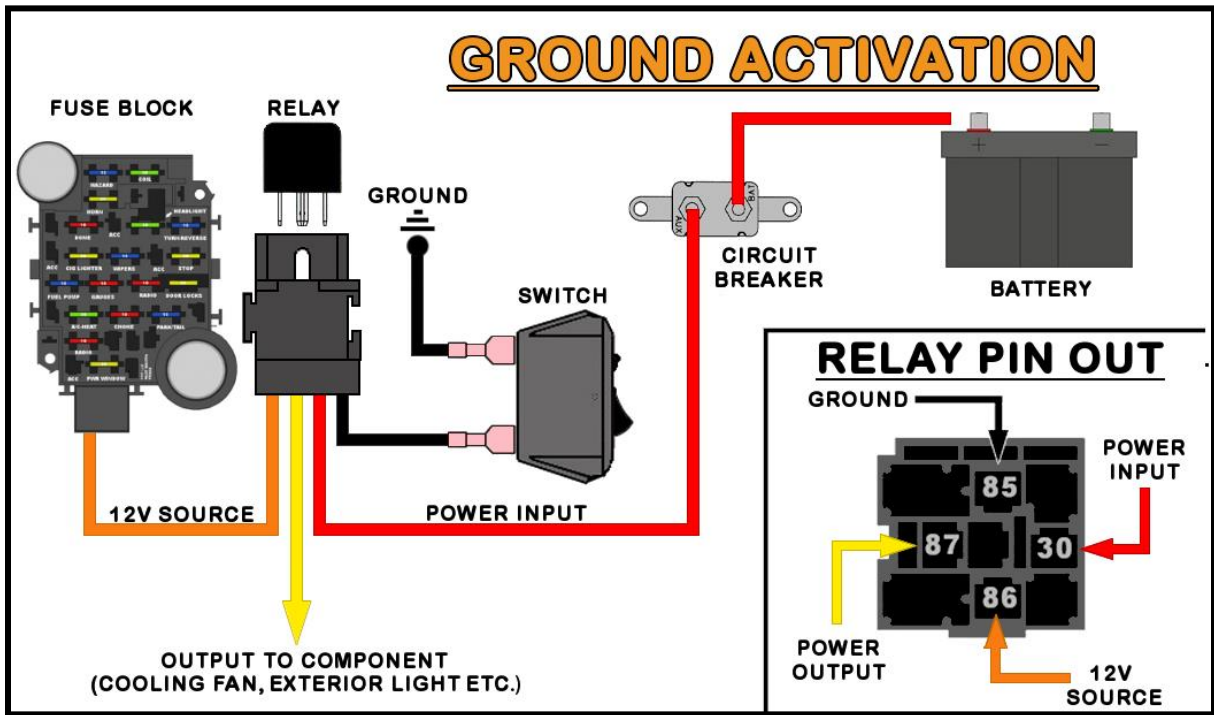

A ground activated relay is just the opposite of the 12-volt activated relay; 12 volts (battery constant or switched) are supplied uninterrupted and the ground wire is switched. The Horn Relay pre-wired in the Painless harness is a Ground Activated Relay. Another example of this method is a thermostat operated fan relay. In this case, however, a thermostatic switch would replace the switch in the drawing above (see below).

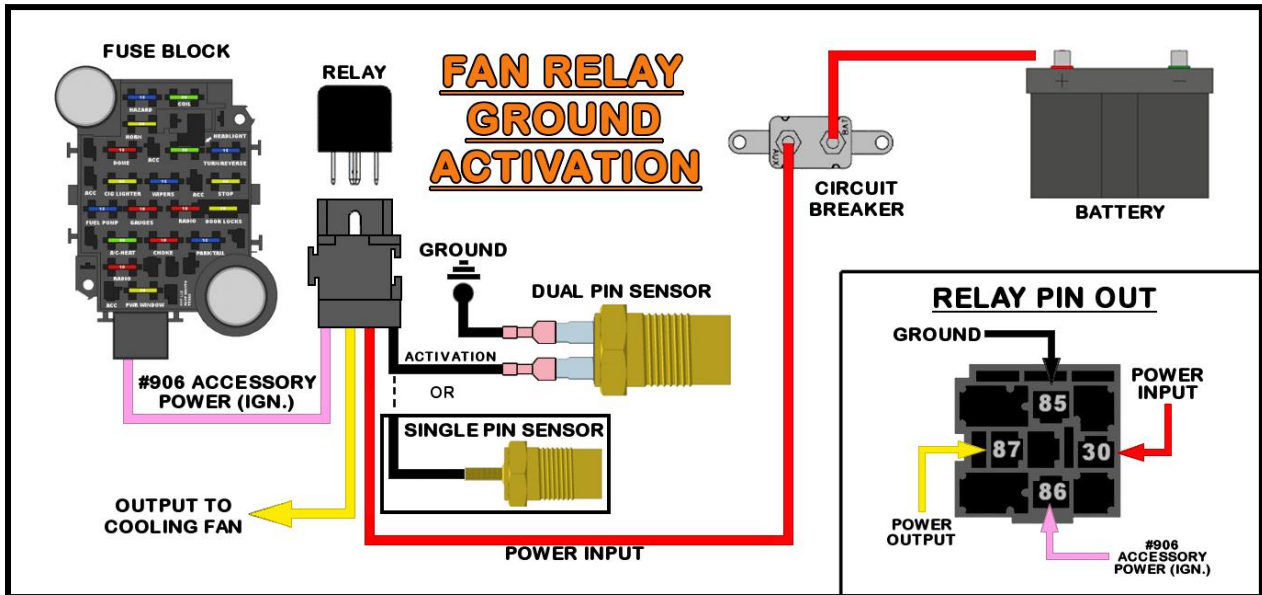

If a toggle/rocker switch is being used without a relay, make sure the amperage of the component you are powering does not exceed the capabilities of the switch or switch failure will occur.

OLD FACTORY HARNESS REMOVAL

During the removal of the old factory harness, avoid making any unnecessary cuts to any wires. The entire harness should be able to come out of the vehicle without any cutting at all unless someone has modified connections.

Labeling the factory harness is highly suggested as it may be helpful to look back at the factory harness during the install of the new Painless harness. Plus, taking this step helps you identify anything that may not be included in the Painless harness and will need to be re-used. Individual wires and connectors can easily be labeled using masking tape.

Take photos or make a drawing of any connections that have multiple connectors, like at the wiper motor, wiper switch, radio, etc., to help with reconnecting the new harness.

Cars with factory air conditioning, power locks/windows, and/or power antenna:

These factory accessory harnesses do not need to be removed during the removal process. They are generally separate harnesses. The power supplies for the separate harnesses simply need to be disconnected. They usually plugged into the front of the factory fuse block or on the factory horn relay.

To aid in the removal and installation of the harness, first, remove the driver seat or bench seat and then the steering wheel. It is not completely necessary to remove the steering wheel; however, doing so allows you to more room to work while removing the factory harness and installing the new Painless harness. Also, **if the Tail Harness is to be routed through the interior of the vehicle**, the sill plates and rear seat will need to be removed to route the wires under the carpet.



PRE-INSTALLATION GUIDELINES

Before moving your new harness into your vehicle, it is a good exercise to lay the entire harness out on the ground and look over the individual sections that make up the harness. This allows you to get familiar with where specific wires are located and to move and regroup any wires necessary. All wires of this harness have ample length to account for the numerous different vehicles the harness can fit. They are marked to help ease the process of routing. This allows you to route your wires cleanly and terminate at the length you find fits your build best.

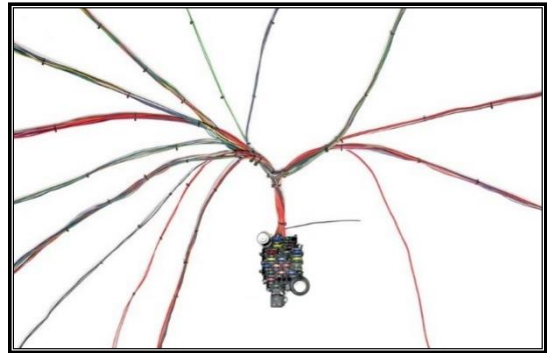

The **WIRE INDEX** on [page 120](#) helps to quickly identify each wire in each section. During this familiarization process is the perfect time to custom tailor your new Painless Harness to your vehicle.

DO NOT SKIP THESE PRE-INSTALLATION STEPS.

- Locate the three wires that make up the **Dimmer Switch Section**. These wires are 14-gauge and colored **LT. GREEN**, **TAN**, and **BLUE/YELLOW**. If you have a later model GM steering column with the dimmer switch on the bottom of the column, re-route the **Dimmer Switch Section** and group these wires with the **Turn Signal Switch Section**.
- Locate the three **TAN/WHITE #962** wires. These wires will connect a brake warn switch and/or an emergency brake switch to the brake warning indicator in the instrument panel. If you are not using either switch or a brake warning light, these wires can be removed from the harness. If you are only using one of these switches, the switch wire not being used can be removed from the harness.
- Locate the **Courtesy Light Section**. If your vehicle has dome light door jamb switches, route the **WHITE #961 PASSENGER SIDE DOOR JAMB SWITCH** wire to the end of the harness away from the fuse block. Route it toward the **Radio Section** and **Instrument Panel Section**.
- **Locate the group of wires on the harness with a section label reading “SEE MANUAL PAGE 16.”** This group of wires contains the following sections: **Brake Switch**, **Reverse Switch**, **Neutral Safety Switch**, and the **Accessory Section**. These sections, and/or the individual wires of the **Accessory Section**, may need to be re-routed from their current position in the harness. To re-route individual wires, it may be necessary to remove the zip-ties and the section label.

- **Brake Switch:** If you have a pedal mounted switch, the brake switch wires can stay in their current location. If you have a hydraulic brake switch installed at the master cylinder or on a brake line, re-route the brake switch wires through the bulkhead (see [page 21 – 22](#)) and group them with the **Engine Section**.

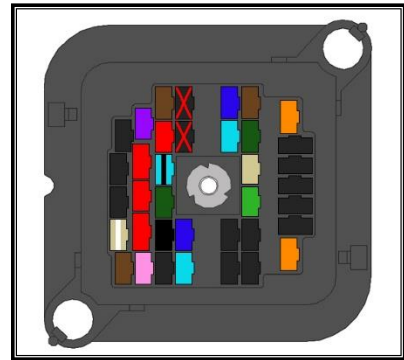

- **Reverse Switch:** If you have a GM, column-mounted reverse switch, a reverse switch on a floor-mounted shifter, or a transmission-mounted reverse switch that you plan to access through the transmission tunnel or floorboard, the **Reverse Switch Section** wires can stay in their current location. If you have a transmission mounted reverse switch and need to access the connection in the engine compartment, re-route the **Reverse Switch Section** through the bulkhead to the **Engine Section**.

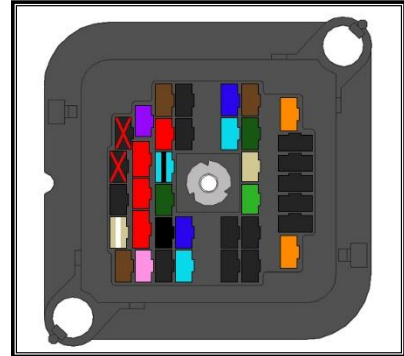

- **Accessory Section:**

YELLOW #905: If you have a GM, ground activated wiper motor, like most GM firewall-mounted wiper motors used after 1965, the **YELLOW #905** wire of the **Accessory Section** will need to be re-routed through the bulkhead and grouped with the **Wiper Motor Section**.

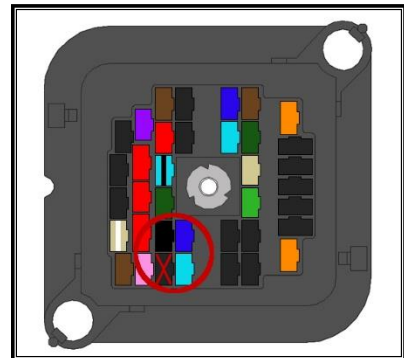

See the image to the right; the circle indicates the 3 wires that make up the Wiper Motor Section and the red “X” is the empty terminal Painless suggests routing the **YELLOW #905** wire through. Terminals have been provided to allow you to make new connections through the bulkhead; see [page 21 – 22](#) for instructions on how to install them.

If you have a wiper system that is power activated by the wiper switch, re-route the **YELLOW #905** from the **Accessory Section** and group it with the **Wiper Switch Section**.

BROWN #904: This wire provides a switched ignition power source for a factory or aftermarket A/C system. In most cases, this wire does not need to be re-routed.

ORANGE #903: This wire provides a battery power source to a cigarette lighter/power port. In most cases, this wire does not need to be re-routed.

PINK #906: This wire provides a switched ignition power source for an accessory, not exceeding 15 amps. In most cases, this wire is used to provide a cooling fan relay a switched 12v activation source. **DO NOT POWER A COOLING FAN WITH THIS WIRE.** If that is the case, re-route this wire through the bulkhead and group it with the **Front-Lighting Section** (see image to the right), as fan relays are generally mounted on the inner fender or core support under the hood. If the **PINK #906** wire will be used to power some other accessory, re-route the **PINK #906** in the harness to wherever the accessory is located. A diagram showing this wire and a fan relay can be seen on [page 36](#).

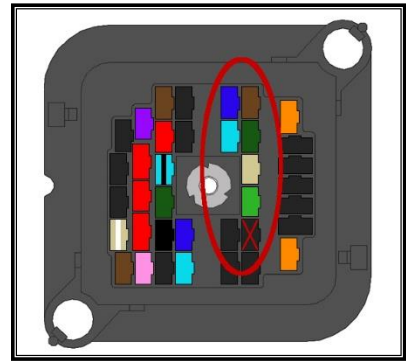

- Locate the **Instrument Panel Section**. Vehicles with a factory engine temperature indicator light, instead of an actual gauge, may notice a tab on the ignition switch labeled “GND” or ground. This will send a ground source to the light when the ignition switch is in the “START” position. This will illuminate the light, letting the operator know the light is functioning. When the key is returned to the “ON/RUN” position, the switch no longer provides ground and the light goes out. To connect this Indicator light so it functions in this manner, either run the **#921 GREEN** from the temp sender to the ignition switch and from the ignition switch to the light or from the temp sender to the light and from the light to the ignition switch.
- This is also the perfect time to remove any wires you will not be using.
- Read through this manual with the harness laid out in front of you. Take note of wires you may not need and remove them from the harness. This will clean up the appearance of the install.
- If you are running mechanical gauges, or if you are using an aftermarket gauge cluster or individual gauges that require their own 2 or 3-wire sensors, you can remove the sending unit wires running from the **Engine Section** to the **Instrument Panel Section**.
- The Choke wire, **RED #954**, can also be pulled back to the fuse block if you have a mechanical choke or if you are running fuel injection.

Painless does not recommend removing any power wires from the fuse block as they can be used to power other things.

When bundling wires into groups, use zip-ties, split loom, or tape. The exposed wires in the engine compartment and wires running to the rear of the vehicle are best protected by wire loom or covering. *Painless offers the **Power Braid Kit part #70920 and the Classic Braid #70970 to fill this need. These kits include everything you need to properly protect your new chassis harness.***



FUSE BLOCK MOUNTING

To begin mounting the fuse block, locate the pre-existing bulkhead opening in your firewall. If your vehicle does not have a bulkhead opening in the firewall, use the template found on [page 126](#) to create one. For those with a pre-existing bulkhead opening, you may need to enlarge the 2 mounting bolt holes; these holes can be found next to the upper right and lower left of bulkhead opening. A $\frac{1}{4}$ " drill bit and an electric drill will be required for this modification.

- Using the drill, enlarge both firewall mounting holes. This allows the supplied $\frac{1}{4}$ " fuse block mounting bolts to pass through the firewall.



With the bolt holes drilled to $\frac{1}{4}$ " in the firewall, the fuse block can now be mounted.

- Remove the 2 nuts and flat washers pre-installed on the fuse block.
- Double Check for any burrs or sharp edges around the square bulkhead opening and the $\frac{1}{4}$ " bolt holes.
- Install the fuse block onto the firewall by inserting the bolts through the fuse block and then through the enlarged firewall mounting holes.

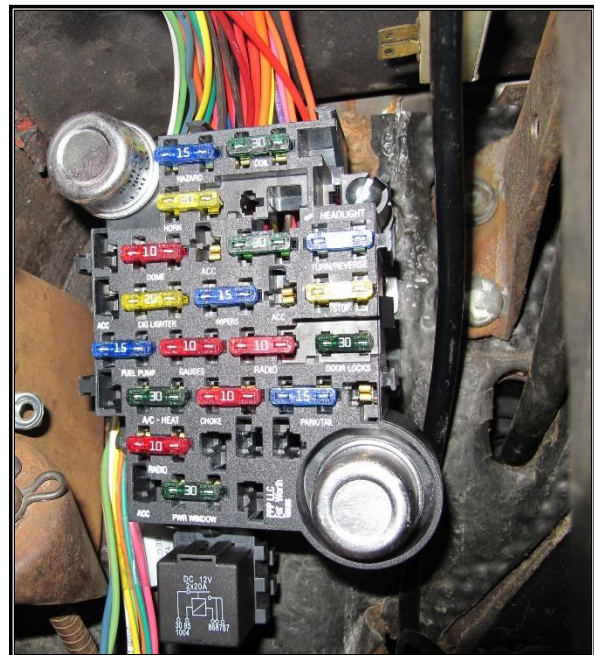

The next step will require a helper.

- On the engine side of the firewall, install the flat washers and nuts previously removed from the fuse block; this will require the use of a $\frac{7}{16}$ " ratchet and socket. A helper with a flat head screwdriver will be needed on the inside of the vehicle to keep the bolts from turning while the mounting nuts are tightened.



ENGINE HARNESS

The engine harness is broken down into 2 major groups of wires leaving the bulkhead connector:

- Light Section: contains wiring for the low brake switch, headlights, high beams, marker lights, park/turn signals, horn(s), and grounds.
- Engine Group: contains 5 sub-groups of wires.
 - Wiper Motor – contains wiring for the wiper motor
 - Alternator – contains wires need for the charging system
 - Engine Section – contains wiring for oil pressure, temp sensor, electric choke
 - Start – contains a single wire for the MIDI fuse.
 - Starter Solenoid – contains a single wire from the NSS to the starter solenoid.

ENGINE BULKHEAD

The photo to the right shows the interior bulkhead coming through the firewall in the engine compartment. The engine harness will plug directly into this connector. However, before doing so, there is an optional feature built into this connector that can be beneficial to your install.

In the engine compartment and highlighted/circled in the photo to the right, you will see that there is a 7-pin portion with two pins having a terminal pre-installed. Both pins will have power when the ignition key is in the ON / RUN position. This will make wiring up most underhood accessories requiring a switched power source easier than having to source power from the inside of the vehicle.

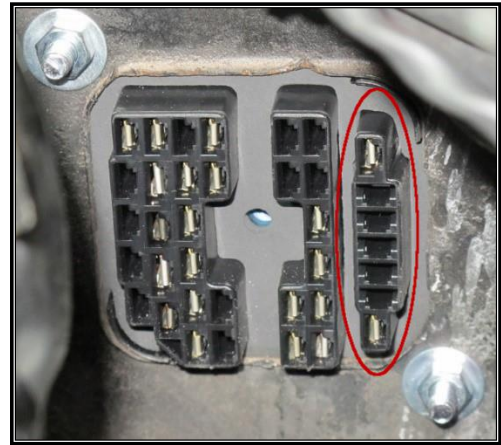

The ignition switched power on these (2) pins comes directly from the ignition switch. **These pins are both UNFUSED and must have an inline fuse (not supplied), no larger than 10 amps, installed before being routed to a component needing power.**

If you need to power a component needing more than 10 amps, a relay will need to be installed. See relay wiring and activation on [pages 13 – 14](#) for detailed schematics. If you do connect one or both pins to a relay, be sure they are connected to the “86” terminal on the relay. Connecting to this terminal turns the relay on when the ignition switch is in the ON/RUN position.

Looking at the mating bulkhead connector on the engine harness, as seen to the right, you will notice the wires for the ignition switched pins are not populated. This is to prevent un-fused wires running out into the engine compartment. There is no harm in leaving these ports open if you do not require any additional switched power sources.

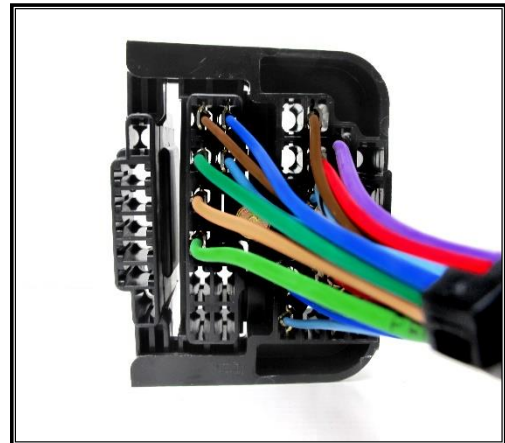

To utilize these switched power sources, you must add wires to the engine harness bulkhead. Terminals have been provided in the parts kit for these connections (see [page 22](#)). These terminals will accept 18-14-gauge wire, using a $\frac{1}{4}$ ” strip length, and will need to be installed with roll-over style crimpers as shown on [page 4](#).

If any wires were added to the bulkhead connector, group each wire with the section of **Engine Harness** nearest to where the fuse will be installed. For instance, if you are mounting an inline fuse on the driver side inner fender to power an accessory, the wire leading to it will route with the **Front Light Section**.

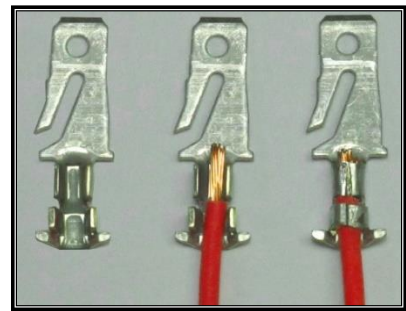

BULKHEAD PINOUT

Before the connection of the bulkhead takes place, look over the pinout to see if there are any wires you will not be using. Things like electric choke, gauge wires (if you are using mechanical gauges or a CAN bus), and tachometer wire are all things some people may not be using. These unused wires can be capped, using insulated butt connectors, and stowed away neatly. However, you may choose to remove these unused wires to clean up the install and to keep unnecessary wires from being taped or wrapped up in the harness. **Read through this entire manual before any wires are removed.** Some wires can be repurposed and used for other things. **UNDER NO CIRCUMSTANCES SHOULD YOU REMOVE ANY OTHER WIRES.**

Removal of these wires is simple and will require the use of a pair of pliers and/or a flat head screwdriver.

- Squeeze the smaller side of the terminal in towards the center of the terminal. This will allow the terminal to be pulled free of the bulkhead.

Be careful not to damage any of the surrounding terminals & wires.

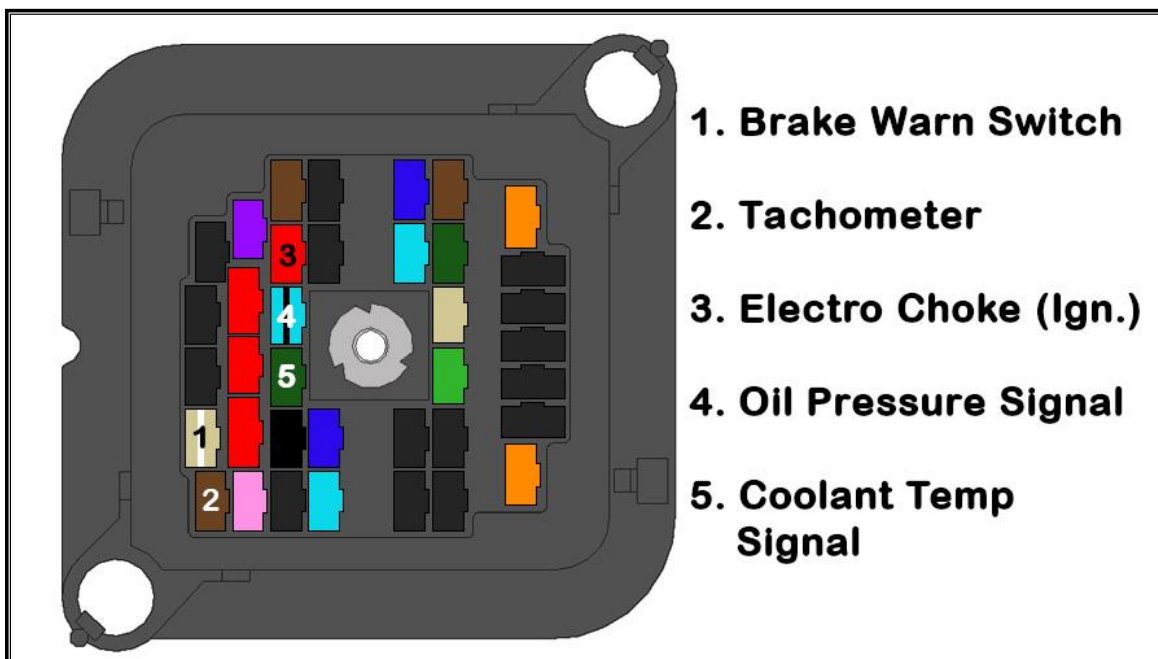
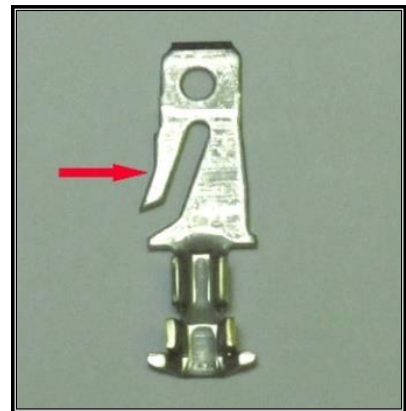

ENGINE BULKHEAD MOUNTING

With all extra wires added to the engine bulkhead connector, if they were needed, it can now be installed onto the firewall connector.

- Find the tube of dielectric grease in the parts kit and apply a small amount of grease into each terminal of the **Engine Bulkhead Connector**.

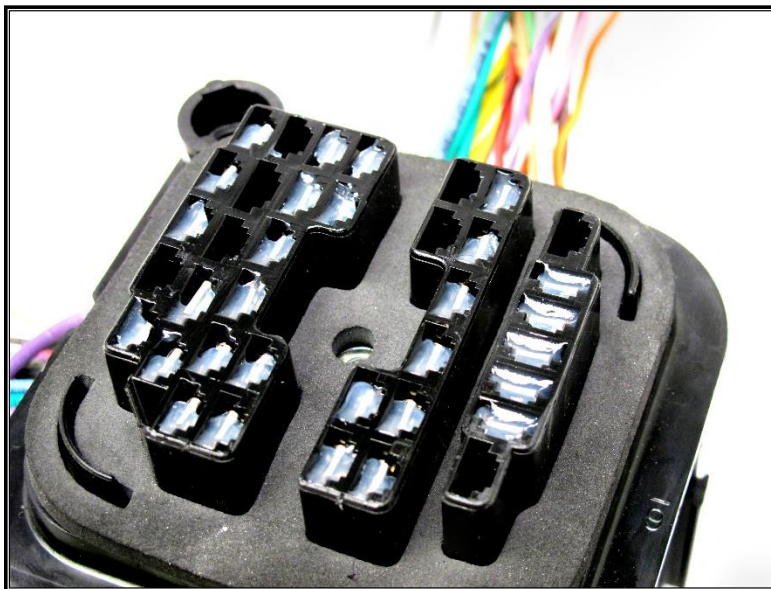

- Push the engine bulkhead onto the firewall connector as far as you can, it will not go all the way on because of the bolt. Make sure the connector is on straight. The terminals of the bulkhead will easily bend
- Using a $\frac{3}{8}$ " socket, tighten the mounting thru-bolt on the engine bulkhead to the firewall connector. **DO NOT FORCE OR OVERTIGHTEN!**

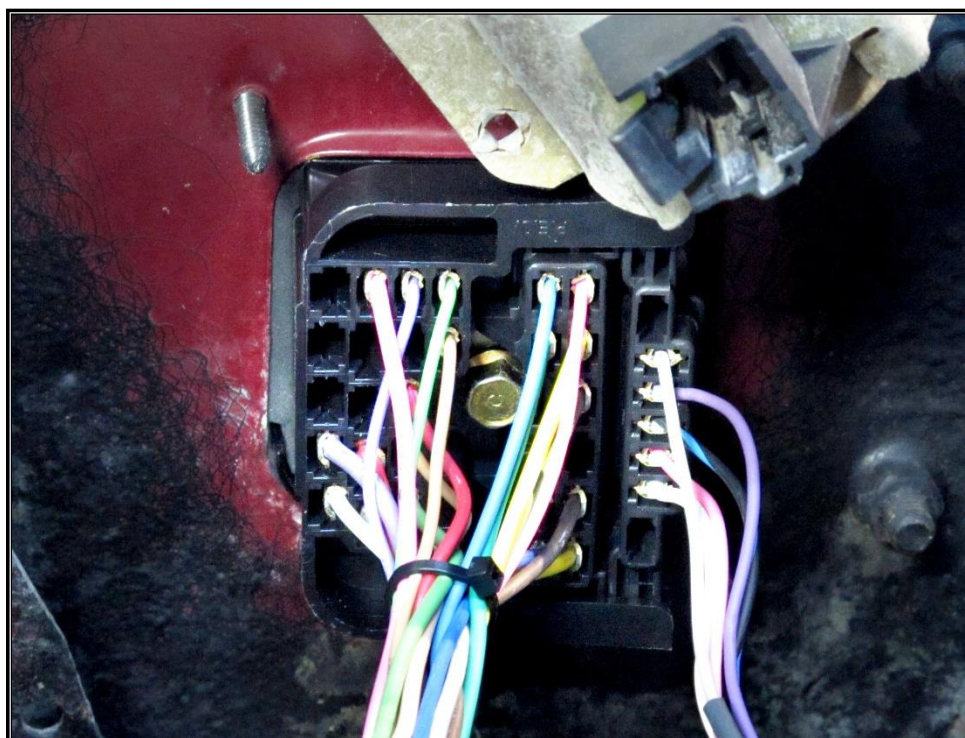

BEFORE ROUTING THE ENGINE HARNESS

The routing of the Engine/Light Harness, covered in the next section, follows much of the factory harness routing. It will be up to you, the installer, to position all the wires away from sharp edges, hood hinges, moving parts, and exhaust heat.

“Umbrella” style clips for zip-ties have been provided for you to attach the Painless harness to the inner fender and the core support in the same fashion the factory did. These zip-tie clips fit into the $\frac{1}{4}$ ” holes left behind by the factory plastic retainer loops, or those you drill yourself.

Remember, as the zip-ties are installed and the harness is routed, wrap the tie around the harness and **LOOSELY** tie the harness to the fender/core support. Make sure you leave enough room to pull and push the harness as you make your connections. Only when all connections are made will the zip-ties be tightened.



If you have an externally regulated alternator, and the regulator is mounted on the driver side core support, re-route the **Alternator Section**. Additional wiring (*not included*) will also need to be added to the **Lighting Section** of the engine harness. See the **Start/Charge Section** beginning on **page 51** for details on these wires before routing any of the **Light Section**.

HARNES ROUTING

- Loosely route all the wire groups to their designated connection points. **NO CONNECTIONS OR CUTTING WILL TAKE PLACE AT THIS TIME.** Harness routing is and should be, a time-consuming task. Taking your time will enhance the appearance and quality of the installation. Please be patient and **TAKE YOUR TIME. REMEMBER TO ROUTE THE HARNESS AWAY FROM SHARP EDGES, EXHAUST PIPES, HOOD, TRUNK AND DOOR HINGES, ETC.**

WHILE ROUTING WIRES: If you are to go through an inner fender well, core support, or any other metal pass-through YOU MUST INSTALL A RUBBER GROMMET.

ENGINE HARNESS

- On the Engine Harness, you can either route the Front Light Section down along the inner driver side fender to the core support or you can route this section inside the fender and over the wheel well to help hide the wires and keep the install looking clean. If you choose to route the Front Light Section inside the fender and over the wheel well, and you plan on looming the wires, do so before routing the harness over the wheel well.

Once at the core support, isolate the wires for the left-hand side headlight and turn signal and possibly the horn wire, depending on where the horns are located. Route the wires for right side lights across the core support to the passenger side of the vehicle. The radiator hold-down will usually need to be removed to allow access to the channel that runs along the top of most core supports where factory wiring once ran. This routing of the front light section makes good use of the zip-tie clips, shown on [page 3](#). Install these clips and loosely zip-tie the harness in place. Tying the wires loosely at first allows the wires to be pushed or pulled during the installation of the Front-Lighting Section.

- Route the Front Ground Harness across the front of the vehicle. Examine the text printed on the wires of the two ground harnesses supplied with this kit to identify the **FRONT** from the **REAR**. Each ground harness has a wire, printed **#969 TO CHASSIS GROUND**. When routing the ground harnesses, orientate the harness so this wire can easily reach a good clean ground source or the negative side of the battery. Zip-tie or tape the front ground harness to the Front Light Section to integrate the two.
- Routing the rest of the Engine Harness wires is easiest to do when their specific connections are made, at this time these wires should be in the center of the vehicle in the engine compartment.

INTERIOR HARNESS

- Route the wires intended for dash-mounted components/switches towards their connection points on the dash at this time. Pay attention to the **Courtesy Light Section** and **Accessory Section** as both bundles contain wires that can/will be routed to different places.
- Locate the **Tail Section** group of wires: this will be both the longest and largest group of wires in this harness. This group of wires must be routed through the lower A-pillar channel where it joins the rocker panel under the driver's sill plates or under the carpet and up and over the floor pan and into the trunk.
- At the back of the vehicle, route the wires to the left and right connections as indicated by the print found on the wires.
- The **Rear Ground Harness** supplied with this kit can now be loosely routed across the rear of the vehicle. Examine the text printed on the wires of the harness to orientate the left-side and right-side connections.

Once all the wires are routed and running to the general location of their components, you can begin making connections. We prefer to start with the **Front-Lighting Section** and work from the front of the vehicle to the back.

NOTES:

ENGINE HARNESS

As stated previously, the engine harness is broken down into 2 major groups of wires leaving the bulkhead connector:

- Light Section: contains wiring for the low brake switch, headlights, high beams, marker lights, park/turn signals, horn(s), and grounds.
- Engine Group: contains 5 sub-groups of wiring
 - Wiper Motor – contains wiring for the wiper motor
 - Alternator – contains wires need for the charging system
 - Engine Section – contains wiring for oil pressure, temp sensor, electric choke, etc.
 - Start – contains a single wire for the MIDI fuse.
 - Starter Solenoid – contains a single wire from the NSS to the starter solenoid.

FRONT LIGHTING SECTION

Once all your wires are routed, we will begin with the Front-Lighting Section connections.

The Front-Lighting Section of this Painless Harness includes all power and ground wires needed to properly hook up both driver and passenger side headlights, front turn signal lights, and park/marker lights. There is also a power wire from the fuse block mounted horn relay to power the horns. All wires in the Front Light Section can be seen in the Front-Lighting Schematic on [page 37](#). Before making a connection, locate the separate front ground harness and route the Front-Lighting Ground Section. The Front-Lighting Ground Schematic can be found on [page 38](#).

If halogen bulbs are being used, a separate headlight relay kit MUST be used. Due to the higher amperage demands of halogen lights, these lights will cause the circuit breaker in the headlight switch to fail. A headlight relay harness provides battery power through the relays directly to the headlight bulbs. The headlight switch will activate the relays, thus drawing only 1 amp of current. This is beneficial for both the longevity of the headlight switch and the brightness of headlight bulbs themselves. Painless offers part #30814 for dual/quad headlights and #30815 for single headlight vehicles.



LEFT / DRIVER SIDE HEADLIGHT

Your first connection in the **Front-Lighting Section** will be the Left/Driver Side Headlight. Three wires make up the connection to the Left Headlight, they are:

LT. GREEN: 14-gauge wire, printed **[FRONT LIGHT SECTION] #908 LEFT HIGH BEAM** this wire provides power to the high beam filament of the headlamp. This wire runs from the dimmer switch and has power when the dimmer switch is in the high beam position and the headlight switch is in the headlight ON position.

BLACK: 14-gauge wire, printed **#969 HIGH BEAM GROUND**. This wire is part of the separate ground harness and provides a ground to the high beam for dual/quad lights.

TAN: 14-gauge wire, printed **[FRONT LIGHT SECTION] #909 LEFT LOW BEAM**, this wire provides power to the low beam filament of the headlamp. This wire runs from the dimmer switch and has power when the dimmer switch is in the low beam position and the headlight switch is in the headlight ON position.

BLACK: 14-gauge wire, printed **#969 HEADLIGHT GROUND**. This wire is part of the separate ground harness and provides a ground to the headlight.

If your vehicle is equipped with dual/quad headlights, meaning the vehicle has a high/low beam light and also a separate high beam light on each side, as shown below, double up the cut-off piece of the **LT. GREEN #908** wire to power the separate high beam. Separate **#969 HIGH BEAM GROUND** wires are provided. The illustration on [page 37](#) demonstrates this.



Connectors (shown in the image below) have been provided in the parts kit to allow proper connection to standard H4, 2 or 3-prong headlamps.

- Route the 3 wires for left/driver side headlamp connection to the back of the headlamp. Removing the headlamp may be necessary and is recommended to ensure the terminals of the headlamp are not damaged during connection. They are easily bent if the connector is not installed correctly.
- Cut all 3 wires to length and strip a $\frac{1}{4}$ " of insulation from them.
- Locate and install terminals onto each wire, making sure to double the high beam wire if you have a separate high beam (quad-headlight). These terminals look like other terminals supplied in the parts kit. You will be using the larger, wider terminals as shown in the photo below.
- Use the connector photo below for proper wire pinout. The connector is shown from the wire insertion side.

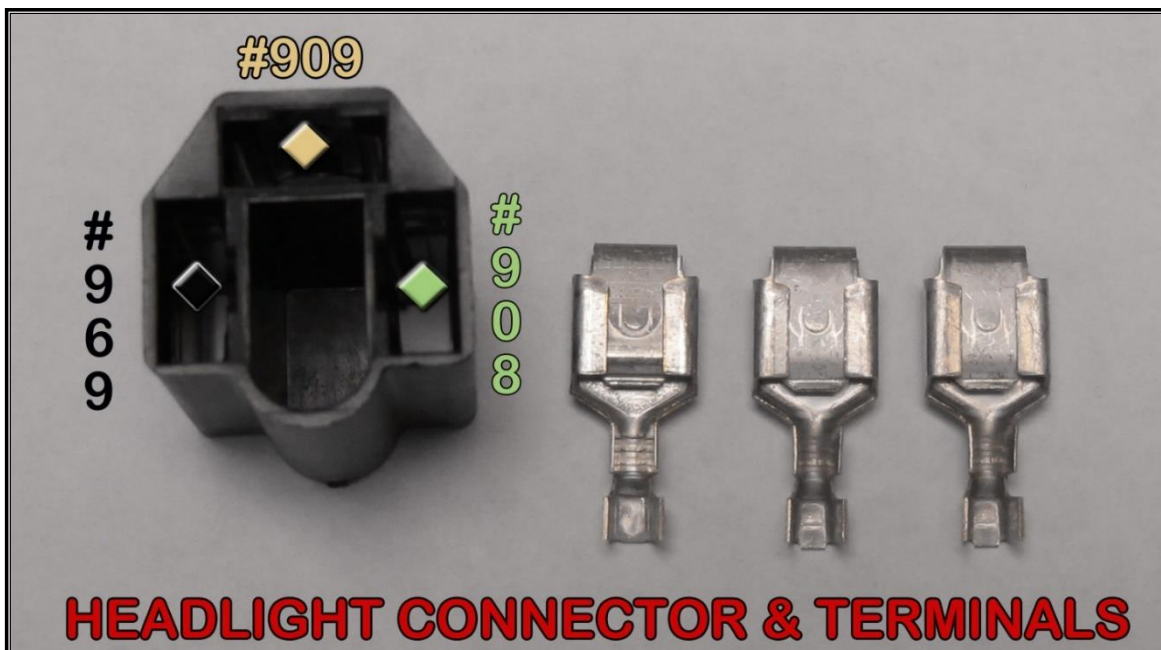

- After pinout is complete, plug the connector onto the prongs of the headlamp. Make sure the connector is inserted straight onto the prongs as these prongs will easily bend making a proper connection difficult.
- Those with separate high beams will use the same 3 cavity connector as the high/low beam headlight even though the high beam only has 2 prongs. You will only use the side cavities labeled **#969** and **#908** seen above.

LEFT PARK / SIDE MARKER LIGHT

The driver side, fender-mounted marker light is the next connection. Some vehicles may not have this light. If this is the case with your install, skip to the next section, **LEFT TURN / PARK LIGHT** on [page 32](#). It can serve one or two purposes: One, it can work simply as a front marker/park light or two, it can work as a park light as well as a turn signal. Both functions are dependent on how you wire the lamp socket.



The park light feature is activated by a power source coming from the headlight switch. This light illuminates any time the headlight switch is in the “PARK” or “ON” position. The turn signal feature is provided by a power source coming from the turn signal switch.

The left side marker requires two wires to work properly. The way you want the light to function determines if both wires need to connect to the park/marker light. These wires are:

BROWN: 18-gauge wire, printed **[FRONT LIGHT SECTION] #927 LEFT PARK LIGHT**, this is a power wire for the park or marker light function. This **#927** is tied to the other **#927** wires in the **Front-Lighting Section**. This wire has power anytime the headlight switch is in the Park/Taillights ON or Headlights ON position.

LT. BLUE: 16-gauge wire, **[FRONT LIGHT SECTION] #926 LEFT FRONT TURN SIGNAL**, this wire is the power for the turn signal function. This wire comes from the turn signal switch and has interrupted switched power from the turn flasher anytime the left turn signal is activated. It also receives interrupted battery power from the hazard flasher anytime the hazard switch is in the ON position.

- Locate one of the socket assemblies in the parts bag. These sockets use a wedge base #194 bulb, **not included**. Splices and heat-shrink from the kit will also be needed.

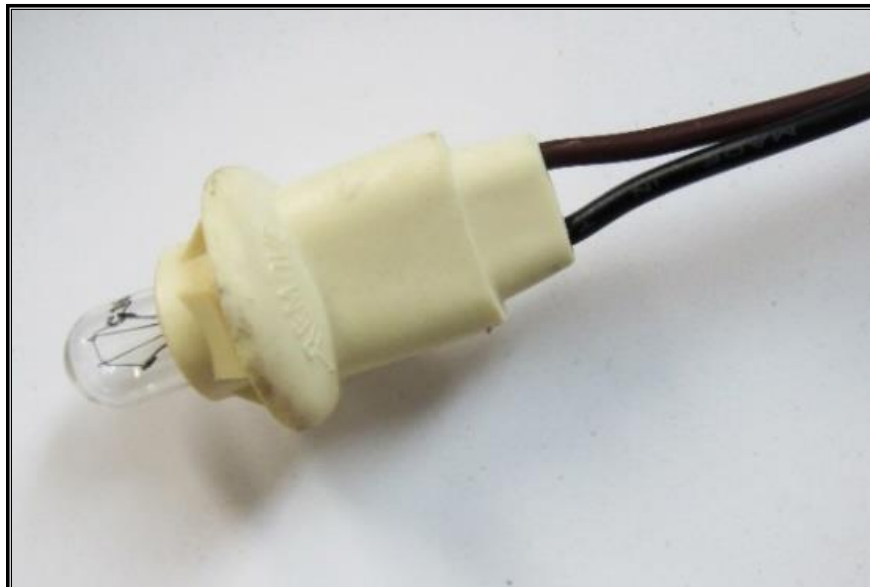

- Looking at the backside of the marker lamp housing, you will see that it has a keyed opening to correspond with the tabs on the socket (as seen in the photo). Temporarily install the socket into the marker light assembly



- Route the **BROWN #927** wire to the **BROWN** wire of the socket and cut the **#927** to length; save the cutoff piece of #927. For the park/marker light to also work as a turn signal, route the **LT. BLUE #926** wire to the **BLACK** wire of the socket and cut the **#926** to length, save the cut off piece of #926.
- Using splices and heat-shrink from the parts kit, connect the **#926** and **#927** wires to the lamp socket. Double up with the cut off pieces to allow connection to the front turn/park light as shown in the diagram below.

If you **do not** want the park/side marker lights to work as turn signals, connect the **BLACK** wire from the socket to a chassis ground source.

If you are connecting the **#926** turn signal wire to the park/ side marker light, you will notice that there are no means for a direct ground to be applied to the light. This is because the path to ground will travel from this park/ side marker light socket to the front turn signal socket, through either one of the wires, and ground through the front turn/park light. The front turn/park signal socket is a higher wattage bulb. So, when the ground passes through that bulb it will not cause the front lamp to illuminate since it has a greater power requirement than the side park/maker light.

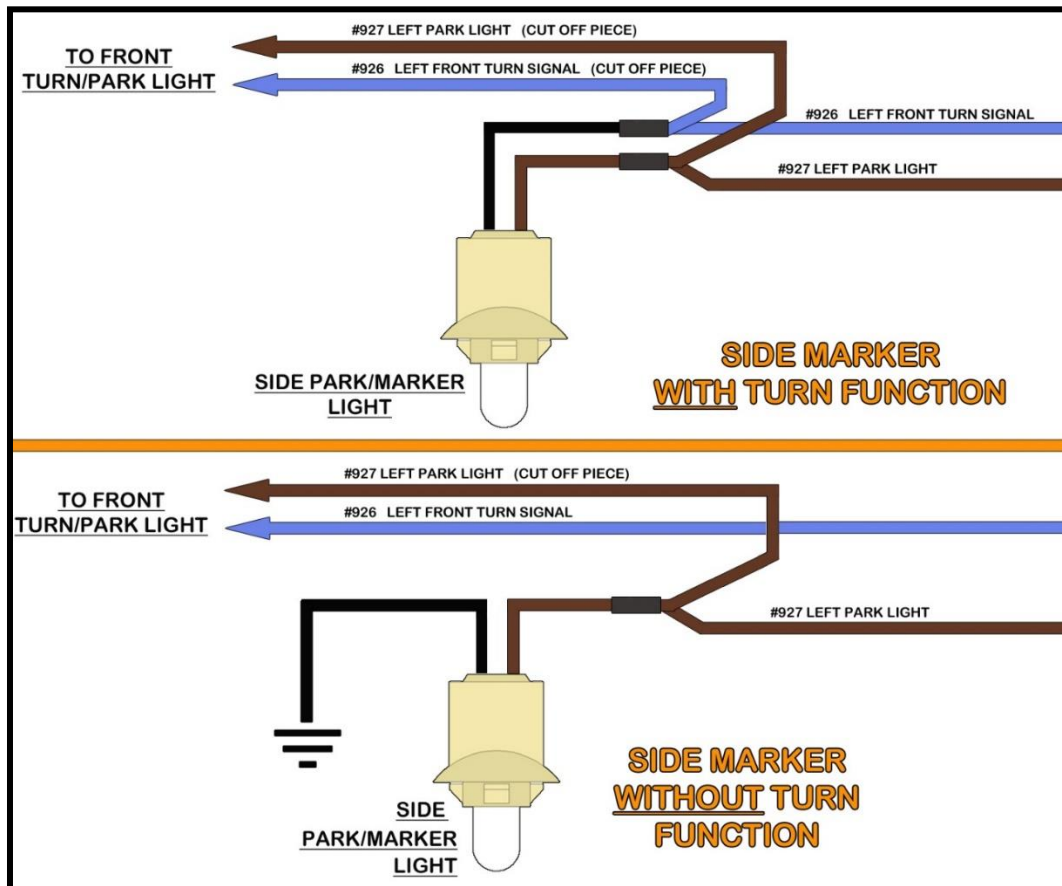

LEFT TURN / PARK LIGHT

The Left Turn/Park Light of the Painless harness consists of 3 wires. These wires are:

BROWN: 18-gauge wires, printed **[FRONT LIGHT SECTION] #927 LEFT PARK LIGHT**, this wire provides power to the park lights. This wire splices to a single **BROWN** wire leading to the headlight switch. This wire has power anytime the headlight switch is in the Park/Taillights ON position.



LT. BLUE: 16-gauge wire, printed **[FRONT LIGHT SECTION] #926 LEFT FRONT TURN SIGNAL**, this wire is the turn signal power. This wire has interrupted switched power from the turn signal flasher any time the left turn signal is activated, and the ignition is in the ON position. It also receives interrupted battery power from the hazard flasher any time the hazard switch is in the ON position.

BLACK: 18-gauge wire, printed **#969 TURN SIGNAL GROUND**, this wire provides a ground source for the turn/park lamp. It is in the front separate ground harness. See [Front-Lighting Ground Schematic](#) on [page 38](#).

If your light has a dual filament bulb and only 2 wires, you do not need to connect a separate ground wire. Your light socket grounds through the mounting of the lens/bucket. If your vehicle has been freshly painted, you will need to clean the paint from the mounting surface of the light housing. The use of a small star washer on the mounting screws can ensure your light housing is grounded properly.

If your light has a single filament bulb, your lens will only act as a turn signal, because the **#927** wires will not have a connection point. Check your local laws to see if front park lights are required; you could violate the law without them. If you can run without the front park lights, the **#927** wires, along with the single wire going to the headlight switch they splice to, can be removed from the Painless harness.

- Route the wires needed for installation to the turn signal. Cut the 3 wires to length and strip $\frac{1}{4}$ " of insulation from all wires.
- The connection of the wires will depend on your install. Many 60s-early 70s GM cars had a 2-pin connection (seen to the right) coming from the turn signal. Connectors and terminals, seen in the photo, have been provided in the parts kit for those applications. Refer to your factory harness for the correct pinout of this connector.



- For those with sockets that fit into the turn signal housing, common GM socket terminals and contacts, seen in the photos to the right, have also been provided.
- Those with these terminals will need to unpin the factory turn signal socket. Take note as to which color wire went into each location, so you know how to install the new wires. If your socket has a ground wire, these terminals typically do not have access to unlock, cut this wire and either attach it to a ground or connect it to the ground wire provided.



Those with spring/contact sockets must reuse the factory springs and socket. Before cutting the factory socket from the harness, take note as to what color wire went into each location, so you know how to install the new wires. When installing the socket to the Painless harness, first, install the wires into the socket. Next, install the spring, and in some cases, a plastic disk, then install the terminal and pull the assembly down into the socket.

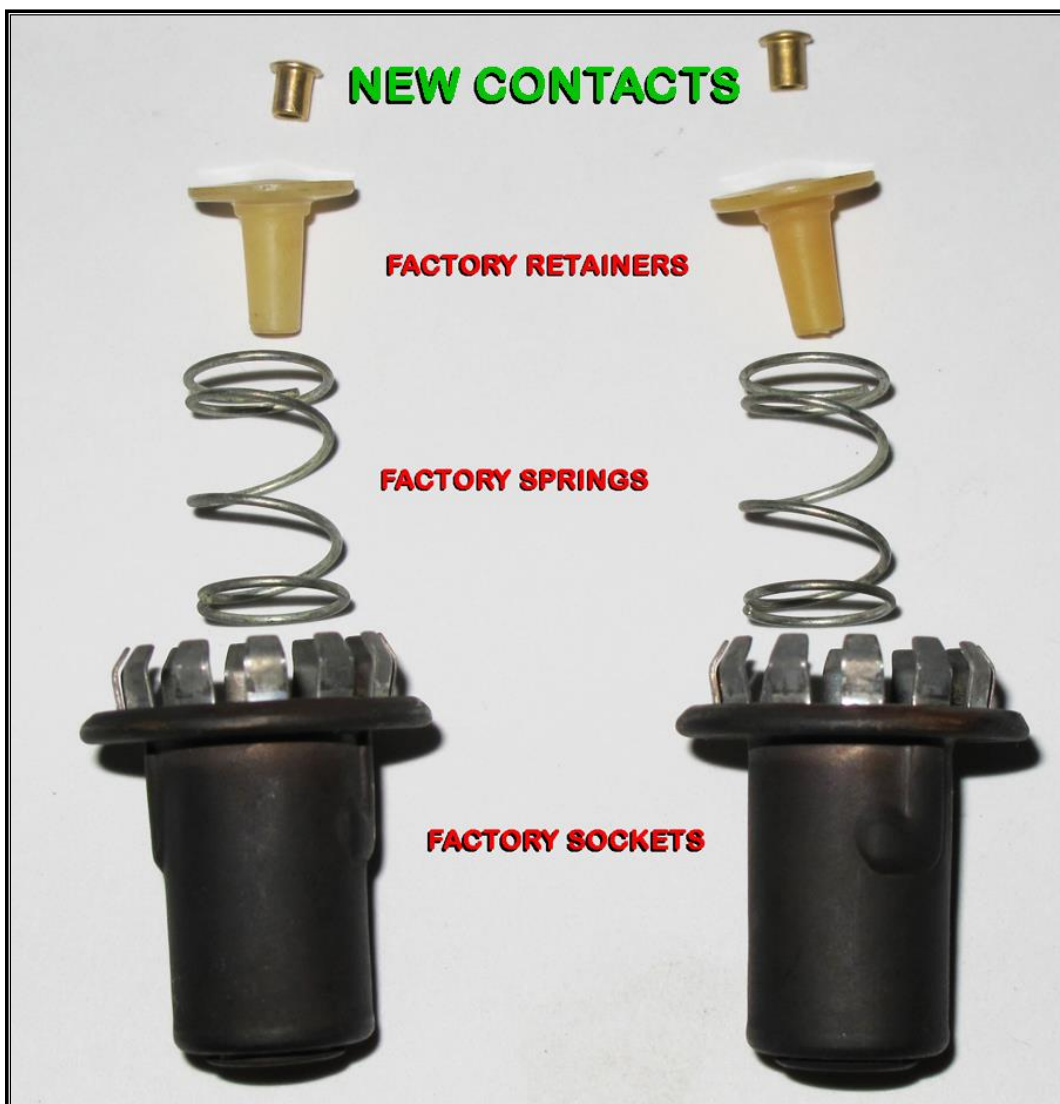

HORN

The **Front-Lighting Section** has a single wire dedicated to connecting to a horn. Most horns ground through their mounting and only require a power connection. This wire is:

GREEN: 14-gauge wire, printed **[FRONT LIGHT SECTION] #924 HORN**, this is a power wire that comes from the fuse block mounted horn relay. It is ground activated by the horn button on the steering column and only has power when the horn button is pressed.

- Route the **#924** wire to the horn. If you pass this wire through any metal surfaces, you will find small grommets in the parts kit to protect the wire.
- If you have a tab on the horn, locate the terminal and connector, seen below, provided in the parts kit.

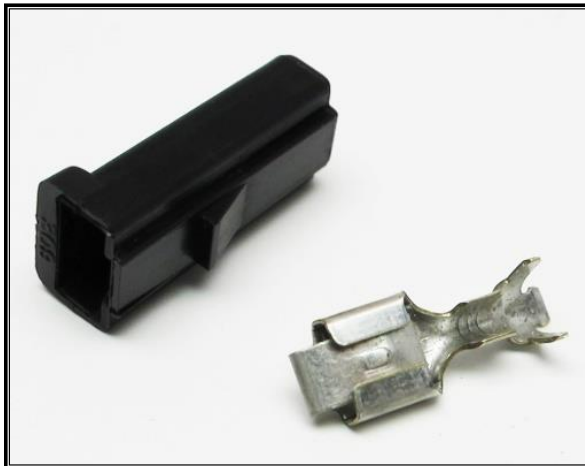
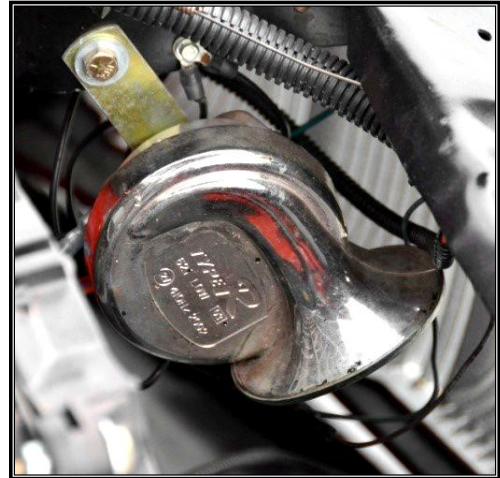

- Ring terminals and heat-shrink have been provided for those with “screw” or “post & nut” connections.
- If your horn has a wire to connect to, then a splice and heat-shrink are needed.
- If your horn requires a ground wire, it will need to be installer provided. Use a ring terminal from the parts kit and attach the other end of the ground wire to a chassis ground source on the vehicle, such as on the core support.

RIGHT TURN / PARK LIGHT & HEADLIGHT

The connections on the right/passenger side of the vehicle all connect in the same manner as those on the left/driver side. The only difference you will find is the turn signal wire for the right turn signal is a different color than the one used for the left turn signal. The right turn signal will be:

BLUE: 16-gauge wire, printed [**FRONT LIGHT SECTION**] **#925 RIGHT FRONT TURN SIGNAL**, this wire is the turn signal power, and goes to the turn signal switch. This wire has interrupted switched power from the turn signal flasher any time the right turn signal is activated, and the ignition is in the ON position. It also receives interrupted battery power from the hazard flasher any time the hazard switch is in the ON position.

GROUND

On the ground harness, is a **BLACK** 10-gauge wire, printed **#969 TO CHASSIS GROUND**, that will provide the main ground source for all the ground wires of the front ground harness.

- Using a ring terminal from the parts kit, connect this **#969** wire to a clean ground source (such as the vehicle's front frame rail) or the negative side of the battery.

This concludes all the connections in the **Front Light Section** of your Painless harness. Go back and inspect the harness layout and once satisfied it is free of moving parts and sharp edges tighten any loose zip-ties.

FAN RELAY

While this Painless harness does not include any wiring specifically for a fan relay. There is an already fused **PINK #906** wire in the **Accessory Section** that can be used for a 12v activation. As mentioned on [page 17](#), to do this you will need to re-route this wire through the bulkhead (see [pages 21 – 22](#) bulkhead pin-out). This wire can be used for the activation of the relay coil only and **MUST NOT** be used to directly power a cooling fan.

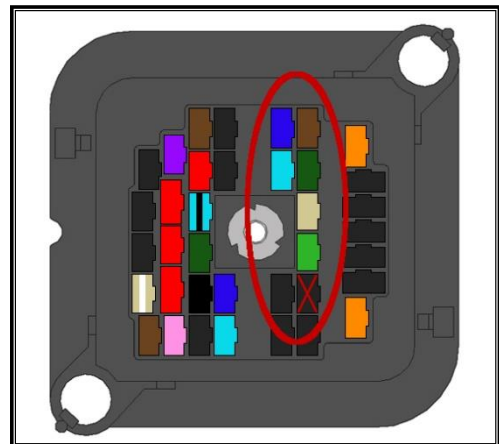

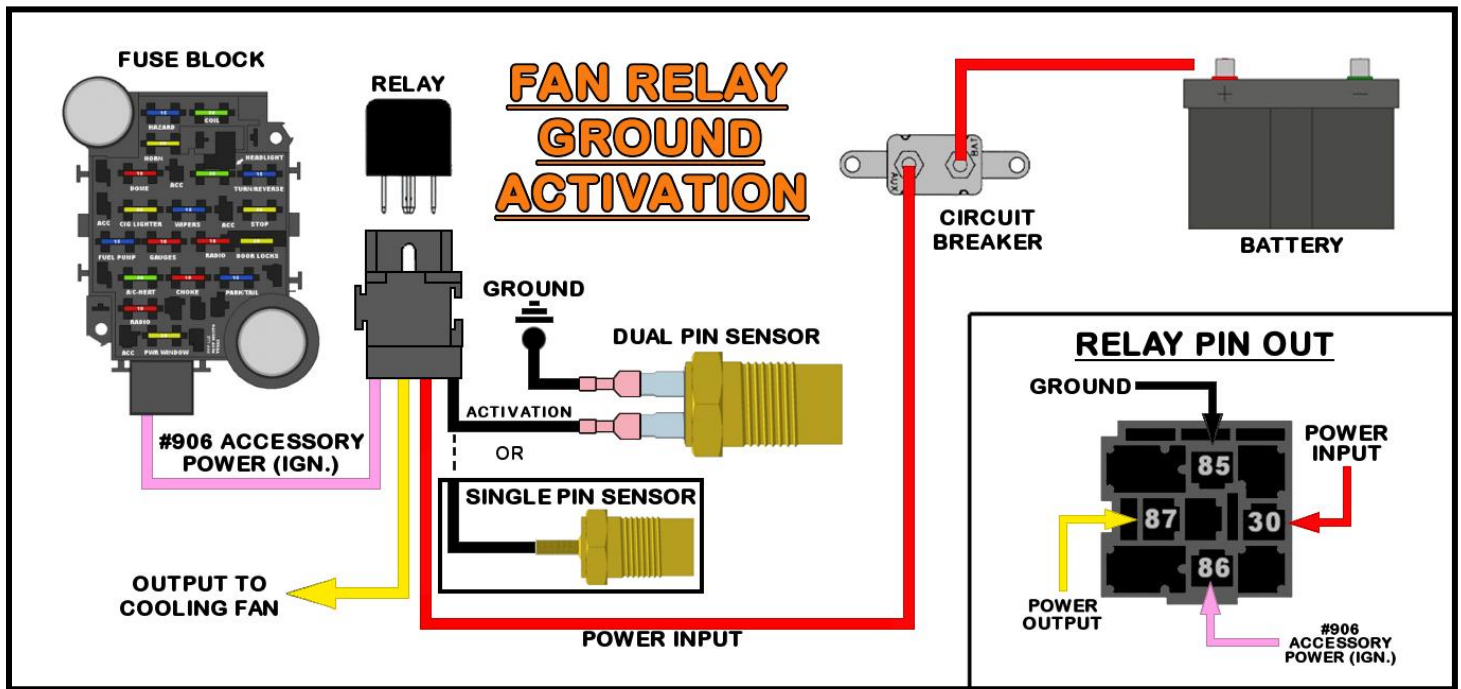
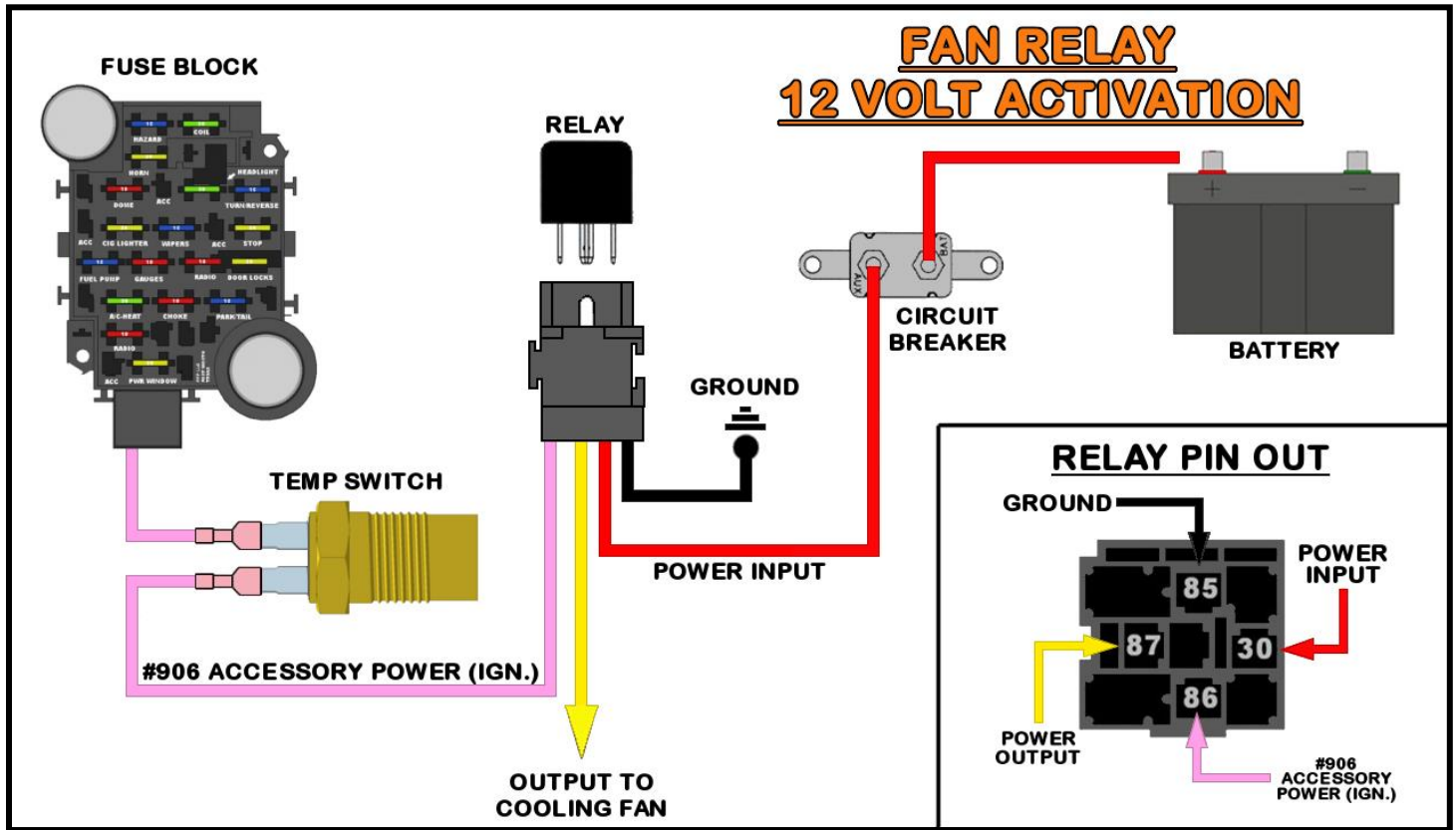

FRONT LIGHT SECTION SCHEMATIC

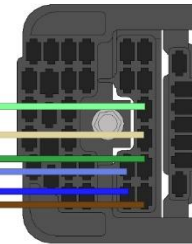
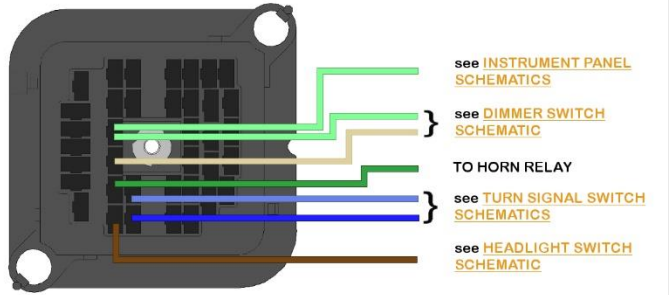
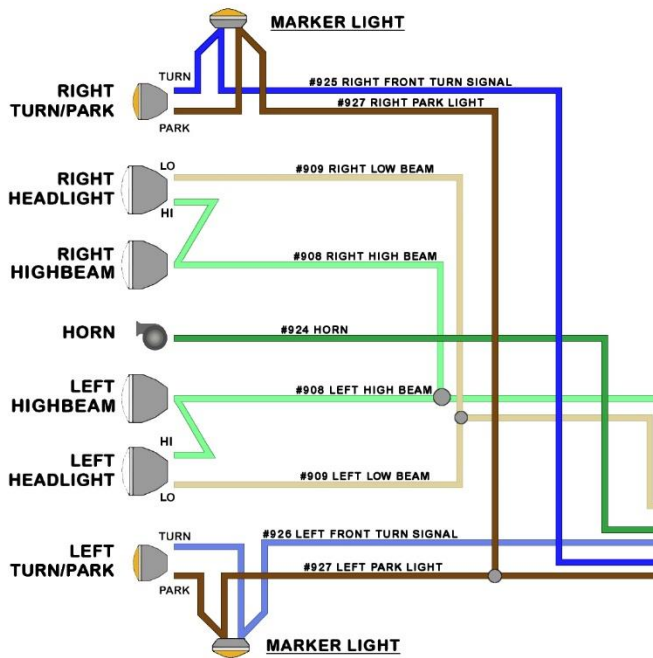
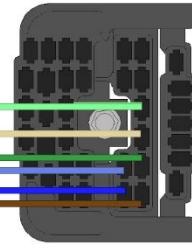
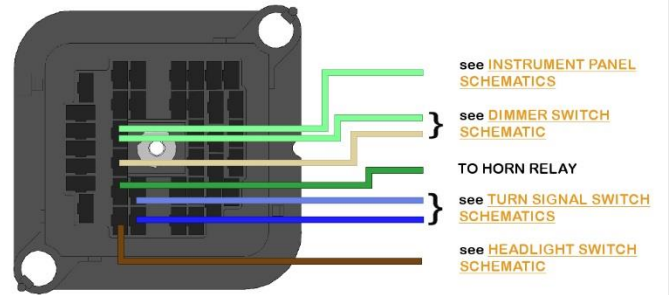
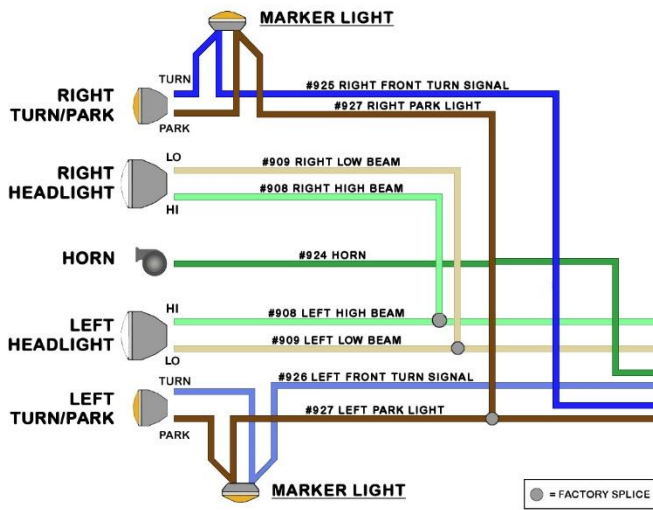

WITH DUAL/QUAD HEADLIGHTS

FRONT GROUND SCHEMATIC

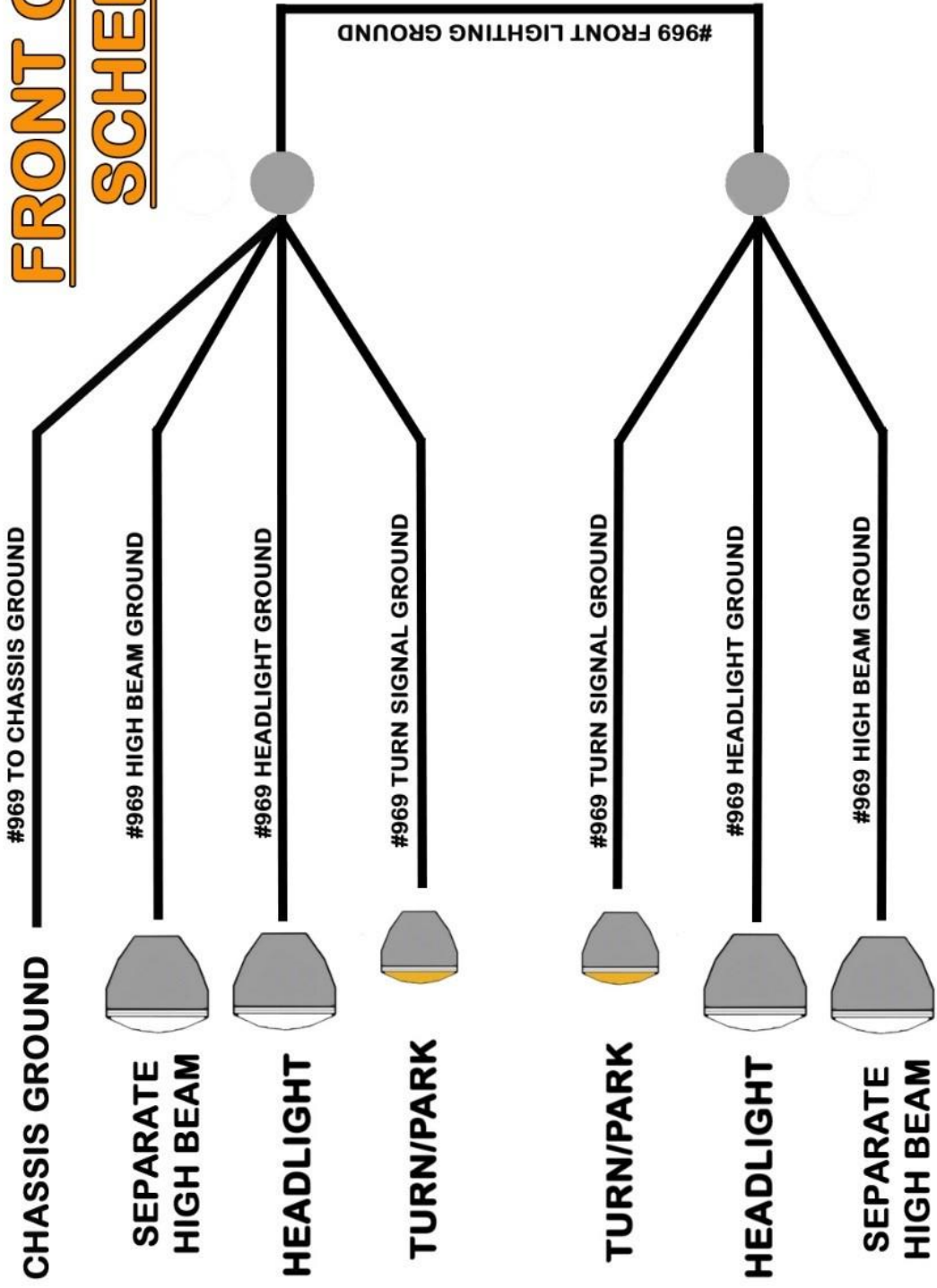

WIPER MOTOR SECTION

The **Wiper Motor Section** consists of 3 wires that run directly between the switch and the motor. If you do not have a wiper system, these wires can be removed from the harness. Depending on your motor, you may also need wire **#905** from the **Accessory Section** for wiper power. This wire should have been routed to the motor or switch on [page 17](#). As it comes, the **Wiper Motor Section** provides the wires for most 2-speed systems. Additional wires, not supplied, will need to be added for those with a 3-speed or intermittent systems.

The following wires provide either power or ground to the wiper motor from the switch. This is dependent on the connection of the **#905** wire. If your wiper motor requires an ignition 12v source directly from the fuse block, like most firewall-mounted GM motors, the **#977**, **#979**, and **#984** will provide ground to the motor.

WIPER MOTOR

The wiper motor connection will require a factory schematic or referring to the old harness. The wires that make up the wiper motor connection can be seen in the [Wiper Schematic](#) on [page 40](#).

Locate the **#977** and **#979** wires in the Painless harness labeled "WIPER MOTOR" and, in most cases, the **#905** wire from the **Accessory Section**. The three wires are:

BLACK: 18-gauge wire, printed **[WIPER MOTOR] #979 LOW/PARK**, this is a signal to the low-speed tab on the wiper motor.

LT. BLUE: 18-gauge wire, printed **[WIPER MOTOR] #977 HIGH**, this is a signal to the high-speed tab on the wiper motor.

YELLOW: 16-gauge wire, printed **[ACC. SECTION] #905 WIPER SWITCH POWER (IGN)**, this wire supplies switched ignition power to the wiper motor from the 15-amp WIPER fuse on the fuse block. For those using a washer pump, this wire will be doubled at the wiper motor to provide power to the washer pump.

- On the motor there are tabs sticking out; these are the connection points for the wiper motor.
- Cut the wires to length and attach the provided terminals and connectors. Take notice of the tabs on your motor. One or more of the tabs have a small dimple protruding; the slotted connectors fit around the dimple.

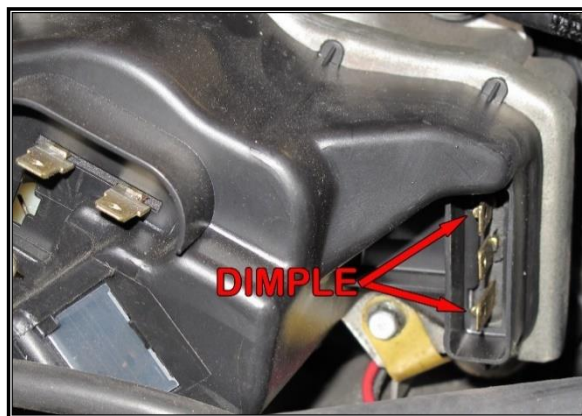

WASHER PUMP

In most applications, the washer pump receives a ground signal from the wiper switch to activate the pump. Once activated, it pumps washer fluid from the reservoir to the washer nozzles. For the washer pump, locate the **BLUE #984** wire in the Painless harness labeled "WASHER PUMP" and, in most cases, the cutoff piece **YELLOW #905** wire from the wiper motor.

BLUE: 18-gauge wire, printed **[WIPER MOTOR] #984 WASHER PUMP**, this wire provides the washer pump with a ground source from the wiper switch when the switch is in the WASH position.

YELLOW: 16-gauge wire, printed **[ACC. SECTION] #905 WIPER SWITCH POWER (IGN)**, this is the cutoff portion of **YELLOW #905** from the wiper motor. This wire supplies switched ignition power to the washer pump from the wiper motor.

These wires can be seen in the [Wiper Schematic](#) below.

- Cut the wires to length and install the terminals into the provided **BROWN** 2-pin connector from the parts kit. This connector will fit most GM Wiper Motor mounted washer pumps, as well as some fluid reservoir-mounted pumps. Refer to your factory harness for the proper pinout. Connect these wires to the tabs on the washer pump.

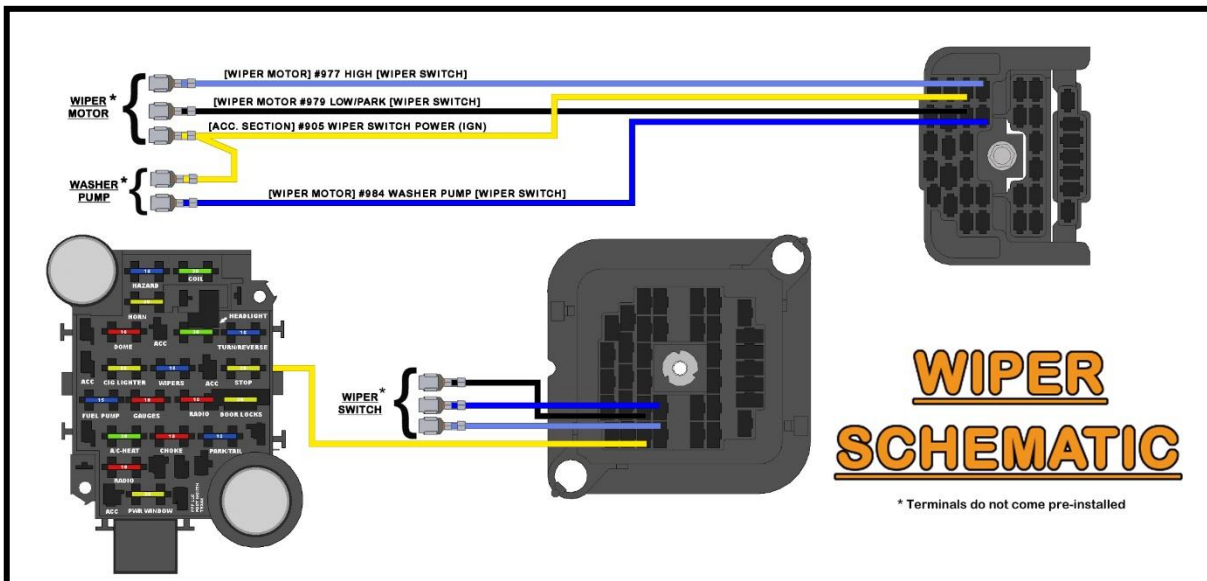

ENGINE SECTION



The **Engine Section** consists of five wires. They connect to the tachometer, oil pressure, and coolant temperature sending units for gauges or lights, the coil or ignition system, a brake warning switch, and an electric choke on a carburetor. Locations of all these components will vary from vehicle to vehicle, so no specific routing instructions can be given.

All wires of the **Engine Section** have ample length to account for the numerous way components can be mounted inside an engine compartment. For example, an ignition box mounted on the inner fender requires more length of wire than a firewall mounted coil.

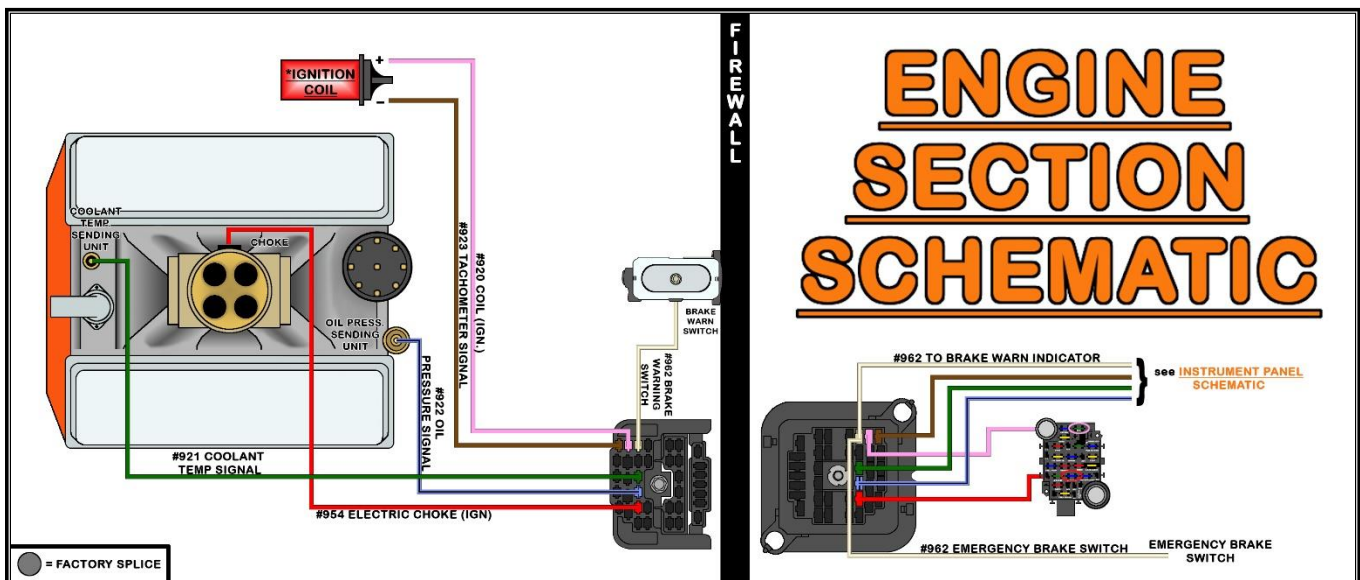

BRAKE WARN SWITCH

TAN/WHITE: 16-gauge wire, printed #962 **BRAKE WARNING SWITCH**, this wire supplies a ground signal to the low brake light on the dash. The wire is connected to the wire going to the emergency brake switch on the interior of the vehicle; see the [Engine Section Schematic](#) on the previous page.

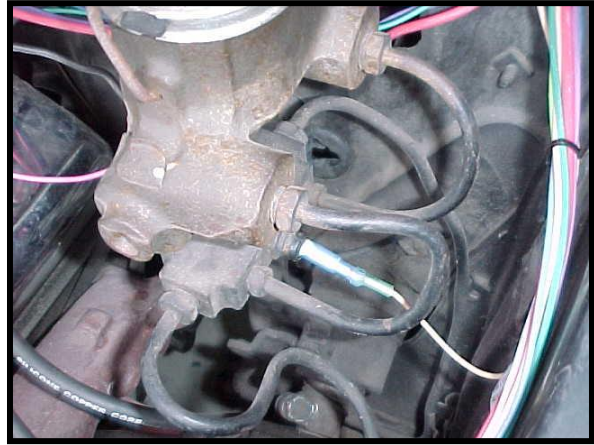

The Brake Warn Switch is a normally open switch that closes and sends a ground signal to the brake indicator light on the dash. This is done when the bias valve inside the proportioning valve has shifted forward or back because of line pressure differences. This is usually caused by a broken/leaking brake line, faulty caliper, or wheel cylinder.

Note: This is a pressure switch, not a fluid level switch. This switch is only necessary if you want the brake warning light in the dash to indicate low brake fluid pressure. If you have aftermarket gauges without a brake warning light, this connection can be skipped, and this wire can either be removed from the harness.

The Brake Warn Switch is located on the proportioning valve near the brake master cylinder. If you have an aftermarket proportioning valve, you may not have one of these switches. Aftermarket valves that have a two-pin switch on them are normally for brake light activation. This type of switch will not work as an activation source for the indicator light on the dash.

Connection to the Brake Warn Switch can be done two different ways:

- You can use an insulated bullet or socket terminal found in the parts kit. Some switches require a male terminal, while others require a socket terminal.
- You can cut the molded connector from your factory harness and splice it to the wire of the Painless kit; splices and heat-shrink have been provided.

COOLANT TEMP SENSOR

GREEN: 18-gauge wire, printed [ENGINE SECTION] #921 COOLANT TEMP SIGNAL, this wire sends a ground signal to the engine coolant temp gauge. If you are using an aftermarket mechanical gauge, this wire is not needed. See the [Engine Section Schematic](#) on [page 41](#).



The coolant temp sending unit/switch can be mounted in the intake manifold or the side of either cylinder head. These will have a peg, tab, or threaded post to connect to, as seen in the photos on this page. Terminals and a factory-style connector have been supplied to allow connecting to a factory-style sensor. Roll-over crimpers will be needed to install this terminal.



Two-wire temperature sensors on fuel injected engines are for engine computer input, not for gauge signal. Also, if connecting to an engine in a vehicle that has electric cooling fans, make certain you know the difference between the coolant temp sensor and the electric fan thermostatic switch. Both sensors can look identical.

If you are installing a new temp sensor or are unsure of the temp sensor currently mounted in your engine, make sure there is no sealant tape on the sensor threads. The tape can interfere with the ground source the sensor needs to read correctly. Liquid/tube sealant or anti-seize can be used on the threads.

- Route this **GREEN #921** wire to the coolant temp sensor, cut to length, and crimp on the appropriate terminal for your connection, and connect.

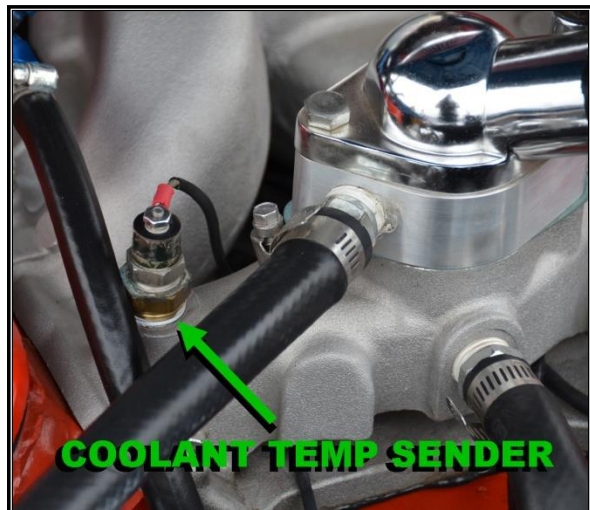

OIL PRESSURE SENSOR

LT. BLUE/BLACK: 18-gauge wire, printed **[ENGINE SECTION] #922 OIL PRESSURE SIGNAL**, this wire sends a ground signal to the oil pressure gauge. If you are using an aftermarket mechanical pressure gauge, this wire is not needed. See the [Engine Section Schematic](#) on [page 41](#).

The oil pressure sending unit will generally be located near the oil filter or on the back of the block behind the intake manifold.

- Route this **LT. BLUE/BLACK #922** wire to the oil pressure sending unit, crimp-on the appropriate terminal for your connection, and connect.

Terminals and a factory-style connector, seen in the photo to the right, are supplied to allow connecting to a “nail-head” style sensor like the one shown above. Rollover crimpers are required to install this terminal.

If you have a 2-wire sensor on a newer, fuel-injected, donor engine, it will not work for your pressure gauge. Two-wire sensors on fuel injected engines are for fuel pump control and are not designed for oil pressure gauge readings. These types of sensors are generally found on GM TBI and TPI engines.



ELECTRIC CHOKE

RED: 18-gauge wire, printed [ENGINE SECTION A] #954 ELECTRIC CHOKE (IGN), this wire provides a switched ignition power source to the choke from the 15-amp CHOKE fuse. It has power when the ignition switch is in the ON/RUN position. See the [Engine Section Schematic](#) on [page 41](#).

When you turn your key to the "ON/RUN" position, the voltage this wire carries heats the bi-metal spring attached to the shaft of the choke. This spring will unravel as it is heated causing the choke to slowly open. When the ignition is turned to the "OFF" position, power is no longer on this wire, causing the spring to begin to cool and contract, closing the choke.

- If you do not have an electric choke, you do not need this wire and it can be capped off and stowed. If you are using a Turbo 400 transmission, see the instructions on the next page before terminating the #954 wire.
- Route the **RED** #954 wire to the + terminal of the electric choke, install the supplied terminal and connector, and connect. If you are using a Turbo 400 transmission, and a throttle switch is in the engine compartment, see the instructions on the next page before terminating the #954 wire.
- Double up the cut off piece of #954 at the choke to provide power to the throttle switch.
- Ensure the choke is properly grounded (the ground wire is not supplied in the Painless harness) before continuing with the installation.

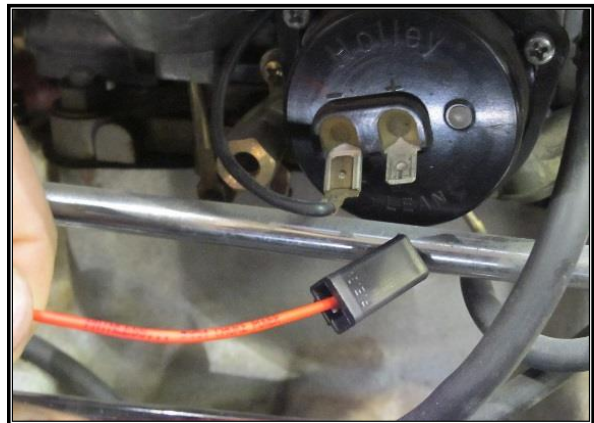
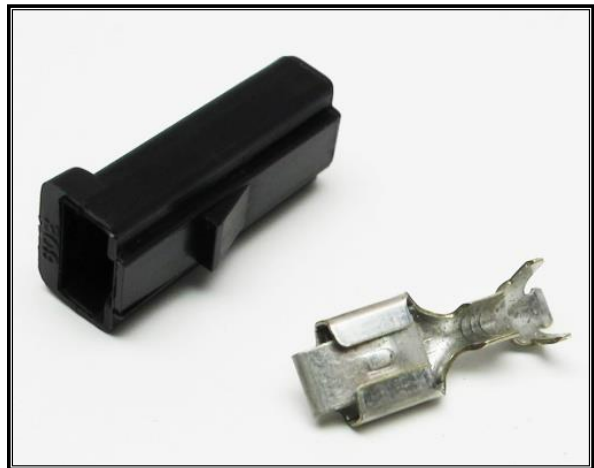

Turbo 400 Transmission

The Turbo 400 transmission requires a 12v power source to downshift the transmission under wide-open throttle. This is done using a throttle switch. The throttle switch is either located on the accelerator pedal inside the vehicle or the throttle linkage on top of the engine.

- Double up the cut off piece of **#954** at the choke. Route this cutoff piece of **#954** to one side of the throttle switch and cut to length. Use terminals from the parts kit to connect the wire.
- If you have a factory, pedal mounted accelerator switch, you can use a switched power source inside the vehicle or you can route the cut off piece of **#954** to the interior, connect at the throttle switch, and then route it back out to the transmission.

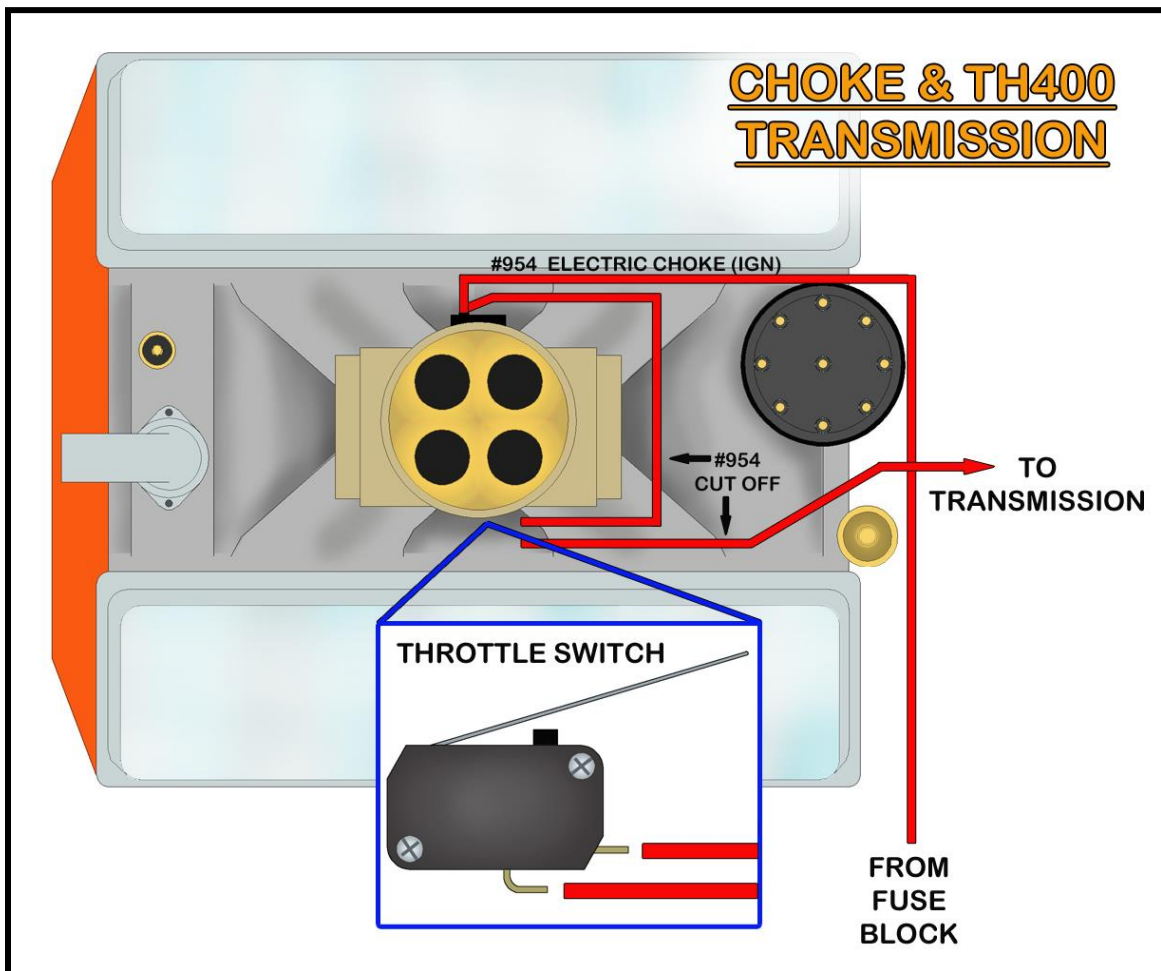
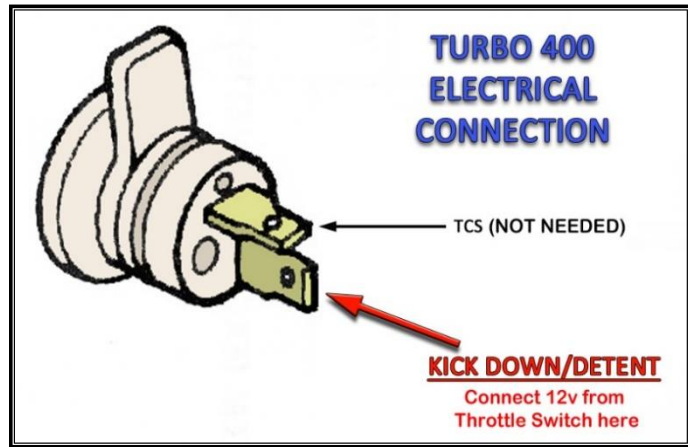

COIL / IGNITION SECTION

A single wire, coming from the fuse block, supplies power to the coil/ignition system. The connection of this wire varies depending on what ignition system (factory or aftermarket) you use. The wire needed to supply a switched ignition power source is:

PINK: 16-gauge wire, printed **[ENGINE SECTION] #920 COIL (IGN.)**, this wire comes from the 30-amp COIL fuse. This wire has power anytime the ignition switch is in the ON and START positions. This wire provides the coil/ignition system with switched power in 1 of 4 ways:

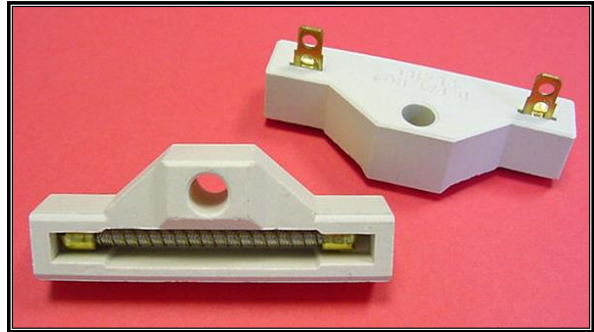

- If the Coil you are using is not internally resisted, a ballast resistor, along with the installer provided bypass wire shown on [page 49](#), will be required. **If a coil is not internally resisted and a ballast resistor is not used, the coil will overheat within a few minutes to the point that it will no longer work.** A ballast resistor can be obtained at your local parts store using part number **RU11**. See the [Ballast Resistor Connection Diagram](#) on [page 49](#).
- HEI coils, internally resisted coils, and most aftermarket ignition boxes do not require the use of a ballast resistor. The **#920** wire connects directly to the + side of the coil. See the [Coil Connection \(NO Ballast Resistor\) Diagram](#) on [page 49](#).
- If you use an aftermarket ignition box, such as an MSD, Accel, etc., this **PINK #920** wire will supply the ignition box with the switched power source it requires. This wire goes to the aftermarket ignition box and **not the Coil**; the ignition box will provide the Coil + connection. This **#920** wire may need to be pulled from the **Engine Section** and routed to where the box is mounted. See the ignition box manufacturer's instructions for a specific connection point of this power source. [MSD Ignition Connection](#) on [page 50](#) has been provided.
- If you have converted to fuel injection, are using a standalone harness, and coil power is supplied through the fuel injection harness (as in LT1/LS1 and newer applications), then this **PINK #920** wire provides the fuel injection harness with the switched power source the harness requires. If you use a Painless fuel injection harness, this **PINK #920** wire will connect to the open-ended **PINK** wire of the fuel injection harness labeled "IGN" or "**Fuse Block IGN.**"



- Route this **PINK #920** wire to its proper connection point and cut to length. Install the appropriate terminal for your connection and connect.

Terminals and a factory-style connector, seen in the photo to the left, have been supplied to allow connecting to the + side of an HEI Coil.

Tachometer

BROWN: 18-gauge wire, printed **[ENGINE SECTION] #923 TACHOMETER SIGNAL**, this wire sends a tachometer signal from the coil to the gauge cluster. This wire only needs to be connected if you are using a tachometer (factory or aftermarket). See the [Engine Section Schematic](#) on [page 41](#). If you do not have a tachometer, this wire may be removed from the harness. Depending on your ignition system (factory or aftermarket), or use of fuel injection, the connection of this **#923** wire can vary:

- Standard factory type installs with an HEI distributor, or external coil ignition systems, require the **#923** wire to be connected to the negative (-) side of the coil. Refer to the diagrams on [pages 49 – 50](#) for proper connection.

Terminals and a factory-style connector are supplied to allow connecting to the (-) side of an HEI Coil (seen in the photo at right). Roll-over crimpers are needed to install this terminal. Insulated terminals in the parts kit are supplied to make other connections.



- If you are running fuel injection and the tach output wire of the fuel injection harness does not reach the tachometer, this **#923** wire will connect to the tach output wire from the ECM.
- If an aftermarket ignition box is being used, such as an MSD, Accel, etc., this **#923** wire will connect to the tach output found on the ignition box. Refer to the [MSD Ignition Connection](#) on [page 50](#) and the ignition manufacturer's installation procedure.
- Route this **BROWN #923** tach signal wire to its proper connection point and cut to length. Install the appropriate terminal for your connection and connect.

Use one of the following four diagrams to properly connect the coil power (#920) and tachometer (#923). Not shown in the diagrams are the wire(s) connecting the coil and the distributor, these are not included.

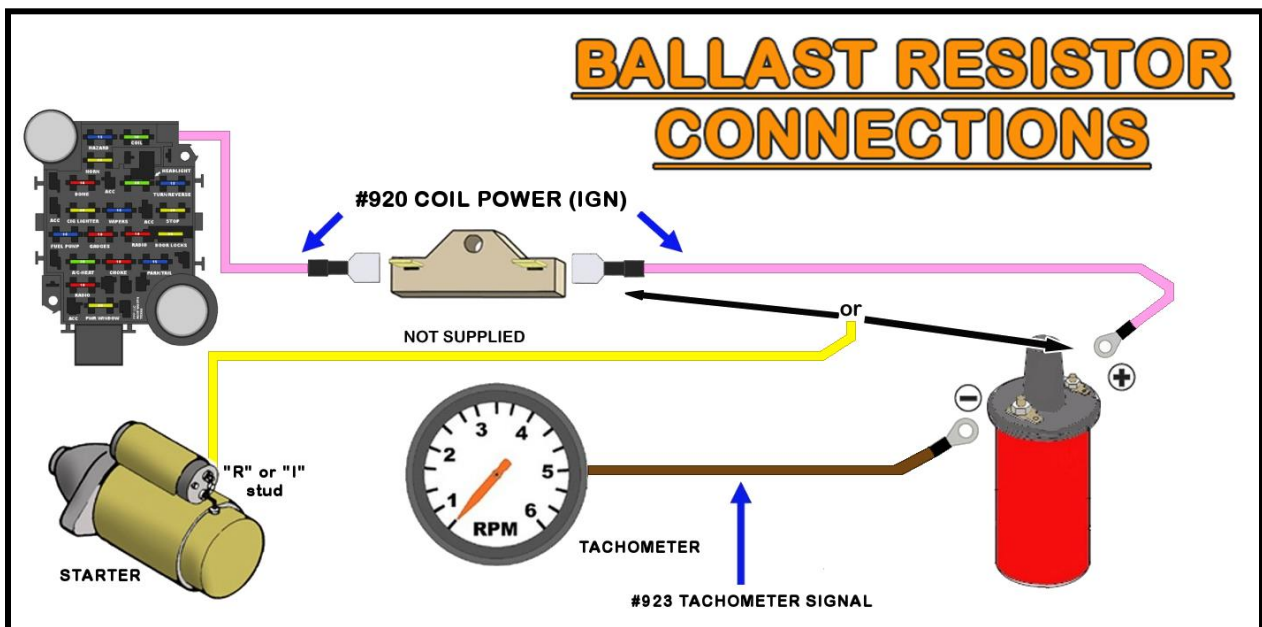
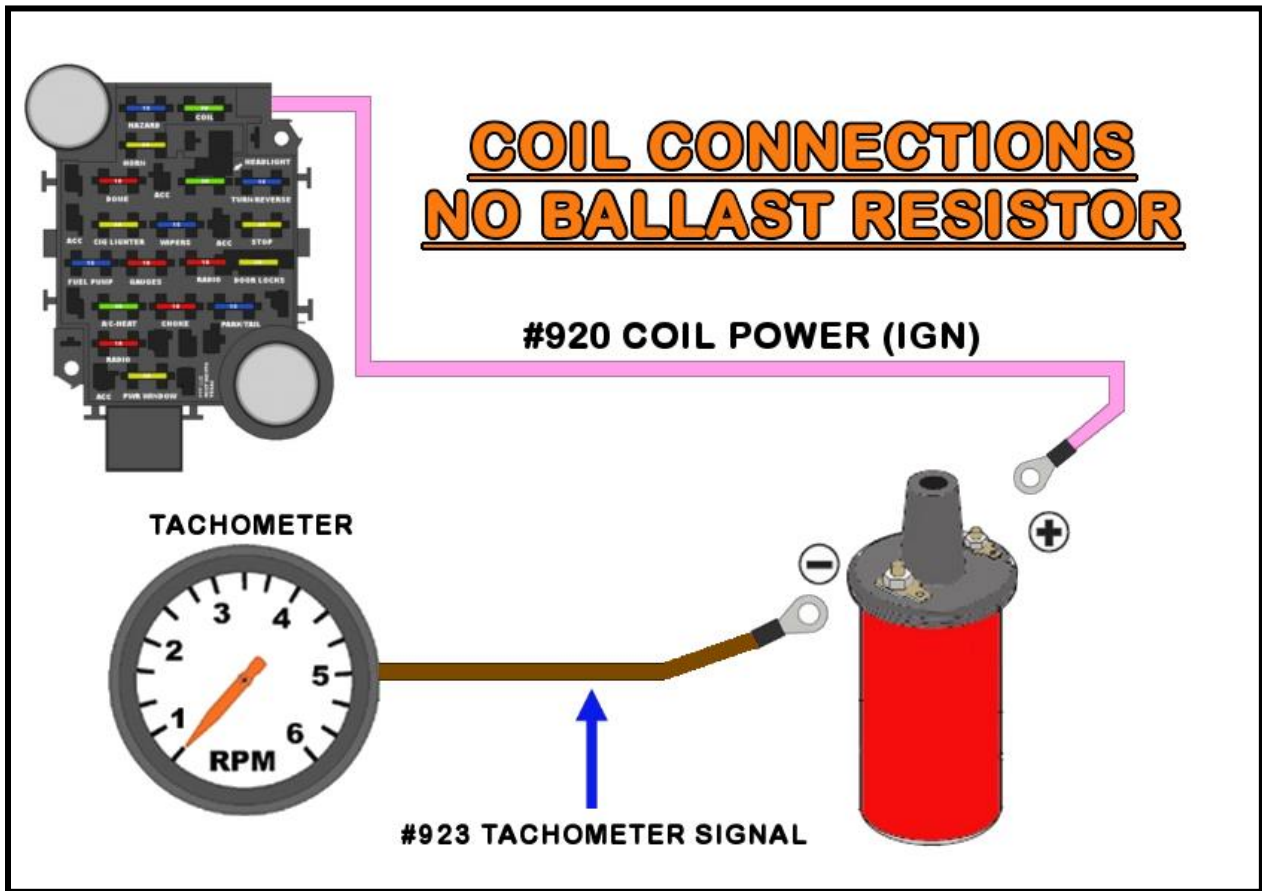

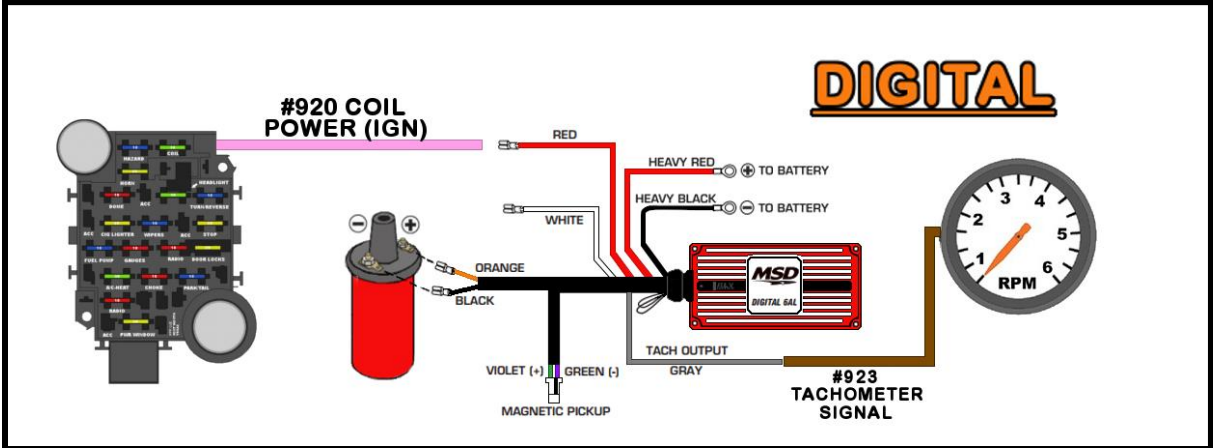
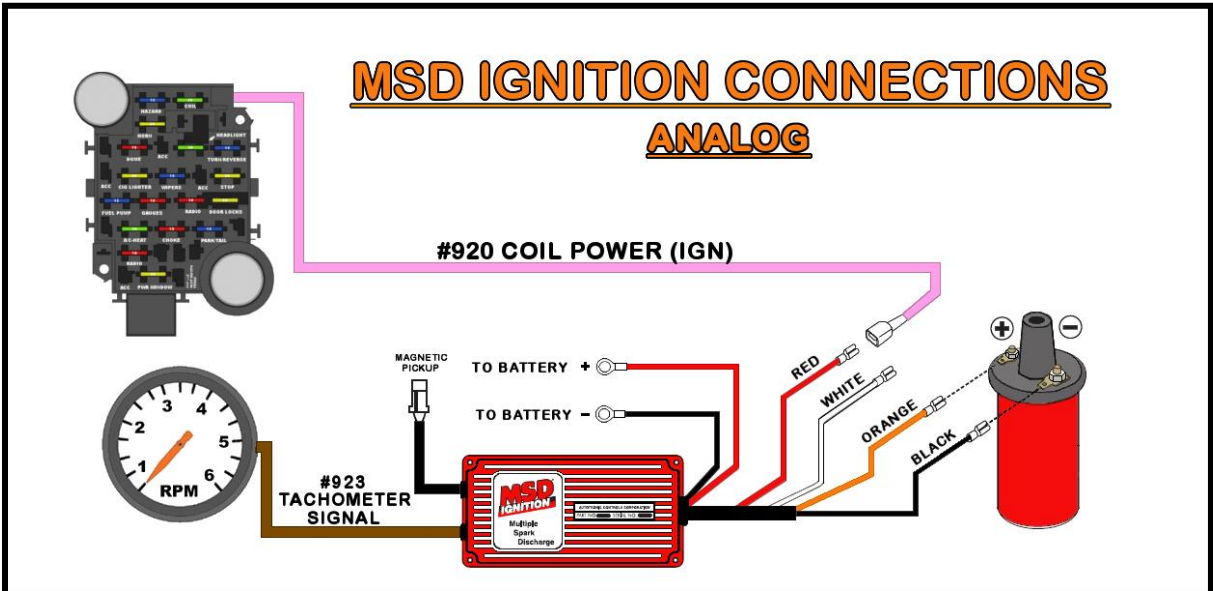
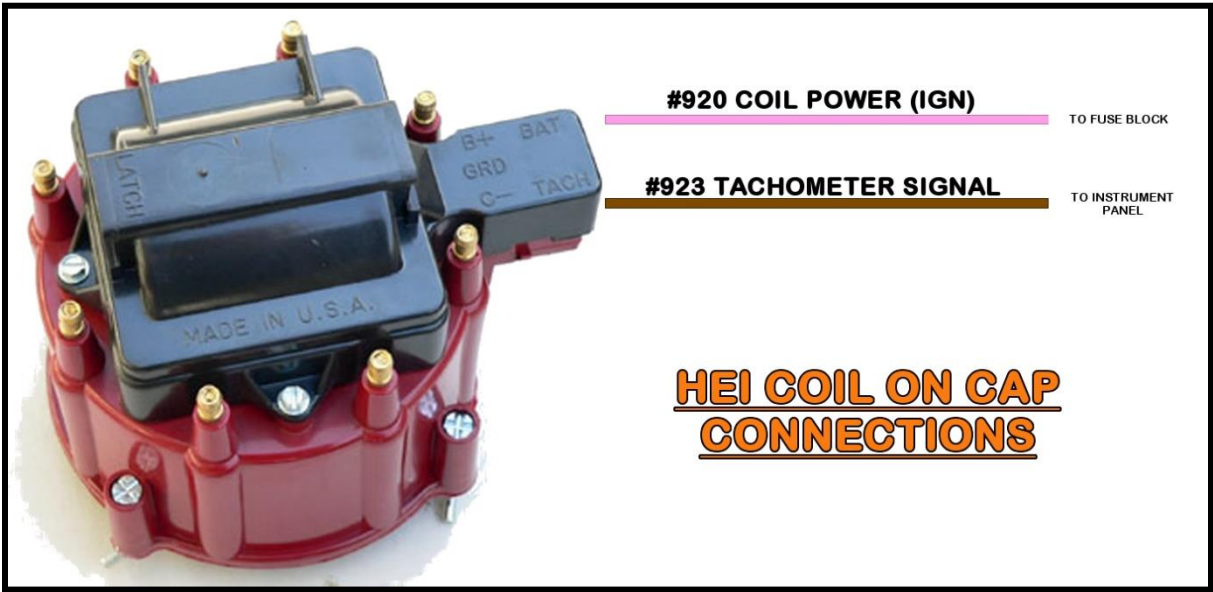

START/CHARGE SECTION

The **Start/Charge Section** consists of 4 wires for connections to the alternator, starter solenoid, and inline MIDI fuse (included with the kit). Locations of all these components vary from vehicle to vehicle so no specific routing instructions can be given.

Locate the bag kit provided with the Painless harness kit labeled “ALTERNATOR.” This bag kit contains the hardware needed to make the appropriate connections to the alternator as well as a covered inline fuse holder.

ALTERNATOR

The alternator connections vary depending on the alternator your vehicle currently has installed. The alternator may also need to be removed to gain access to the connection points.

The one connection all alternators have in common is the output post. This sends power from the alternator to the battery. This connection is made using the large gauge **RED** wire rolled in the kit, it is:

RED: 6-gauge wire, with a tag reading **#915 ALTERNATOR OUTPUT**, this wire provides power out of the alternator to the MIDI fuse and from the MIDI fuse to the battery. This wire is not part of the harness but is a separate, rolled piece of wire provided with the kit. When connected, this wire always has power from the battery. See [Charge/Battery Power Schematic](#) on [page 64](#).

- Locate the rubber alternator boot and a large, un-insulated ring terminal from the “ALTERNATOR” bag that has the right size opening for your alternator post. A piece of the provided red heat-shrink may be used along with the boot or just by itself over the terminal crimp if the alternator boot is not desired.
- If the rubber boot is being used, the end will need to be cut, as shown in the photo to the right, to allow the large gauge wire to pass through.



- Slide the heat-shrink onto the **#915** wire, followed by the rubber boot. A small amount of lubricant such as WD-40 may be applied on the inside of the rubber boot to allow the boot to slide down the wire easier.
- With the boot on, strip about $\frac{3}{8}$ " of insulation from the charge wire and crimp the ring terminal on. You can use a hammer crimper if your hand crimper will not accept this large gauge wire/terminal.
- Connect this wire to the B+/Output stud on the alternator. Once the nut on the output post stud has been tightened, slide the boot over the nut and ring terminal installed on the alternator.



If your vehicle has an aftermarket, **ONE WIRE ALTERNATOR**, meaning it does not require a switched 12v source or regulator connections, or if the Painless or other aftermarket fuel injection harness you are using has an alternator connector, **then this output wire is the only wire used in this section at the alternator.**

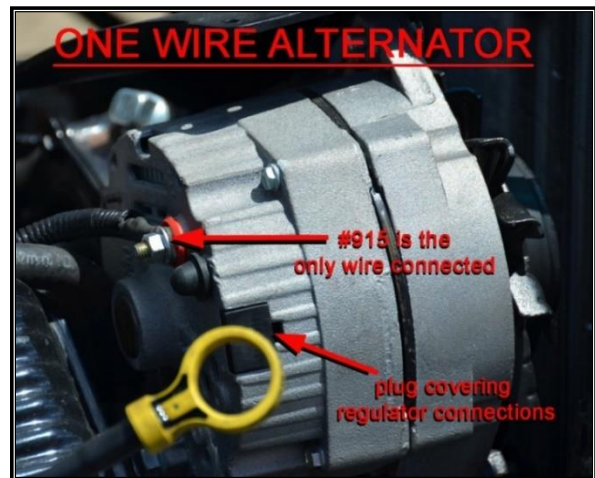

Locate the 2 wires intended for alternator regulator connections; they will be grouped in the **Alternator Section**. These wires are:

RED: 14-gauge wire, printed **[ALTERNATOR] #995 REGULATOR POWER (BATTERY)**, this is the sense wire, it provides a battery power source, or voltage sense, that all voltage regulators require. This wire always has power and comes from the large battery supply splice in the harness. **This wire will not be needed if you have a one wire alternator or a GM CS series alternator.** See the various alternator illustrations on [pages 55, 57, 59, & 60](#) and the [Charge/Battery Power Schematic](#) on [page 64](#).

BROWN: 16-gauge brown wire, printed **[ALTERNATOR] #914 ALTERNATOR REGULATOR POWER (IGN)**, this is the indicator light wire and has switched ignition power from the fuse block. **This wire will not be needed if you have a one-wire alternator.**

If you have a one wire alternator, and only if you have a one wire alternator, you need to insulate the ends of these wires and stow them in the harness, **THEY ARE POWER WIRES**. #995 may also be connected to the output post of the alternator to avoid removing it from the harness since this wire goes into the big battery power splice.

CHARGE INDICATOR LIGHT

Those wanting to add a charge indicator light will need to modify one of the **BROWN** wires leading straight from the bulkhead to the fuse block. The **BROWN #914** of the **Engine Harness** runs to the bulkhead where it connects to a short **BROWN** wire that leads to the 20-amp Power Window fuse.

Unpin this wire from the bulkhead, remove its terminal, and add an extra length of wire (either provided by the installer or cut from elsewhere) to the end. Bulkhead pinout is covered on [pages 21 – 22](#). Connect the wire to the light and then add another length of wire out the other side of the light and back to the bulkhead. See **Charge Indicator Light Schematic** on the next page. Install a new terminal (provided in the kit) on this wire and plug it back into the slot on the bulkhead you unpinned before. **THIS WIRE MUST CONNECT TO BROWN #914 THROUGH THE BULKHEAD.**

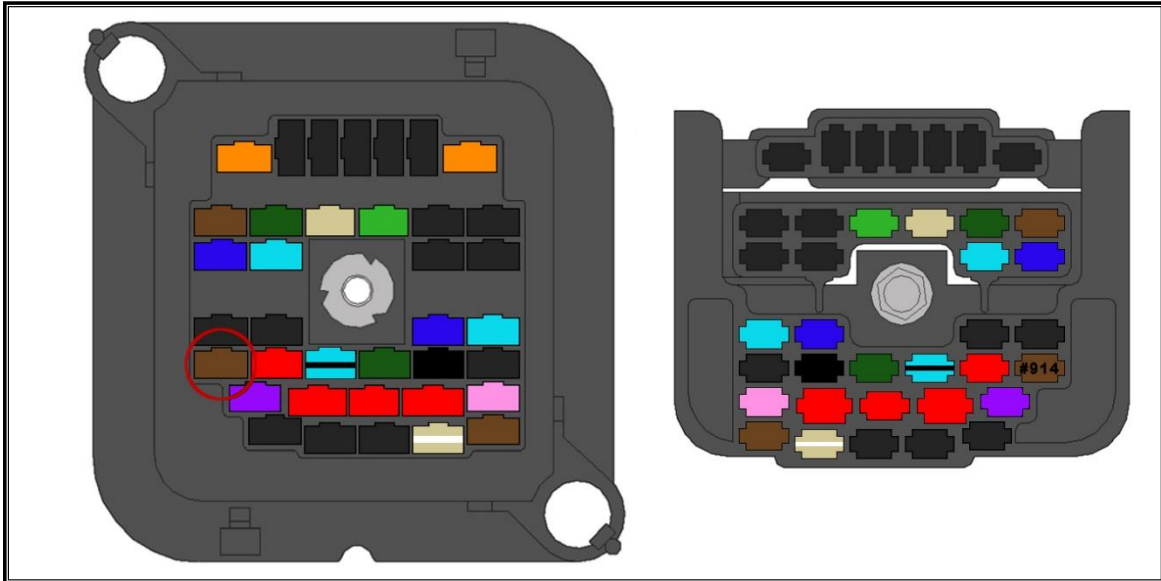

Voltage moving from the fuse block, through the filament, and out to the alternator causes the light to illuminate. This light illuminates when the key is in the ON/RUN position and the alternator is not charging because the engine is not running or when the alternator is not working properly. Once the alternator is charging, the voltage regulator no longer needs the switched ignition voltage supplied by the **#914** wire, which stops the current flow. Since power is no longer flowing through the filament, the bulb does not illuminate.

If you are using a one-wire alternator, a charge light cannot be installed since you do not have an alternator exciter wire going to the regulator.

It is also recommended, but not necessary, to wire in a 15 ohm 2-watt resistor between the power in and power out, as seen in the diagram on [page 54](#). This provides enough power to the voltage regulator to allow the alternator to still charge in the event the bulb burns out. This resistor can be found through online, electronic component suppliers such as Mouser or Allied Electronics under part **#OY150KE**.

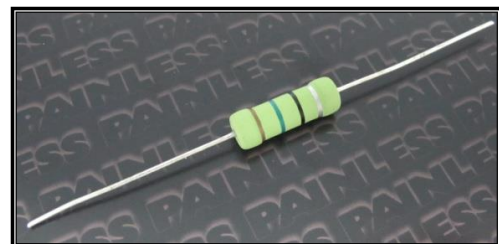

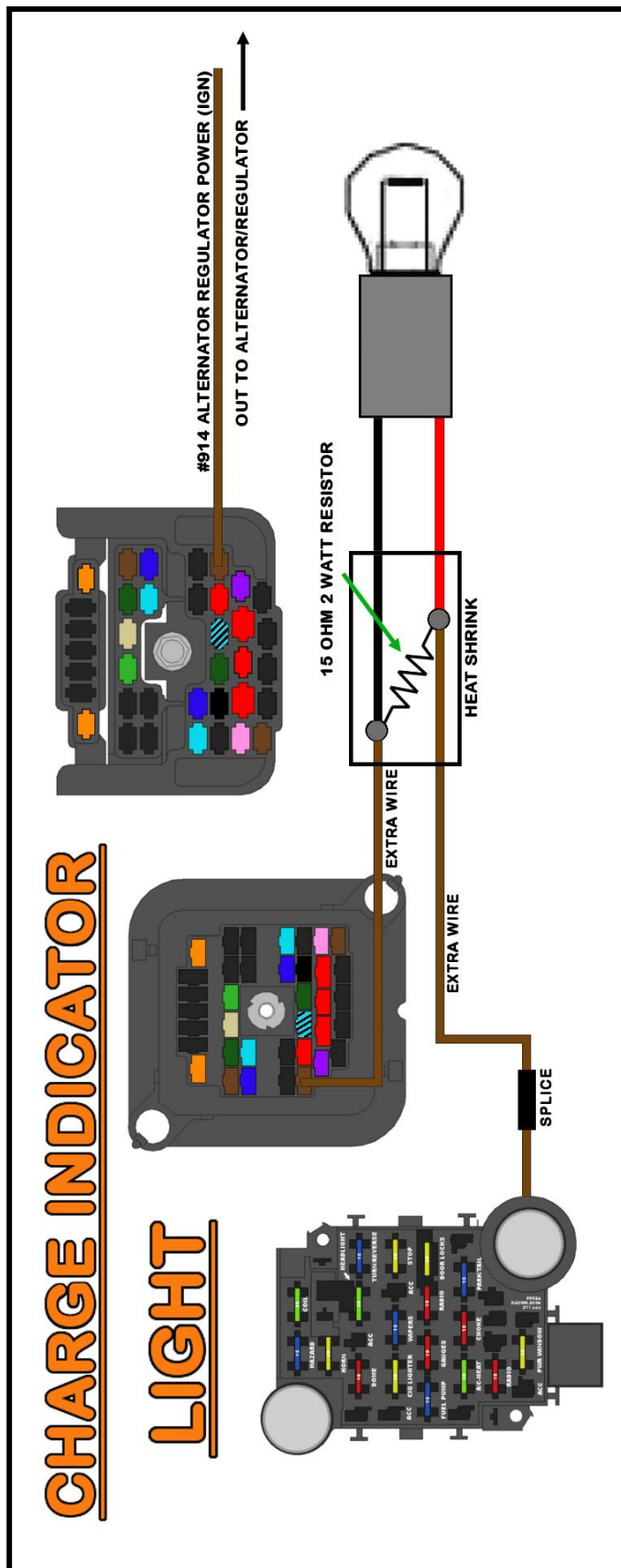

The remaining alternator connections vary based on which alternator is being used. Choose the alternator that best represents the alternator found on your vehicle from those on the next few pages. Then, follow the instructions provided for your alternator.

GENERAL MOTORS SI SERIES ALTERNATORS

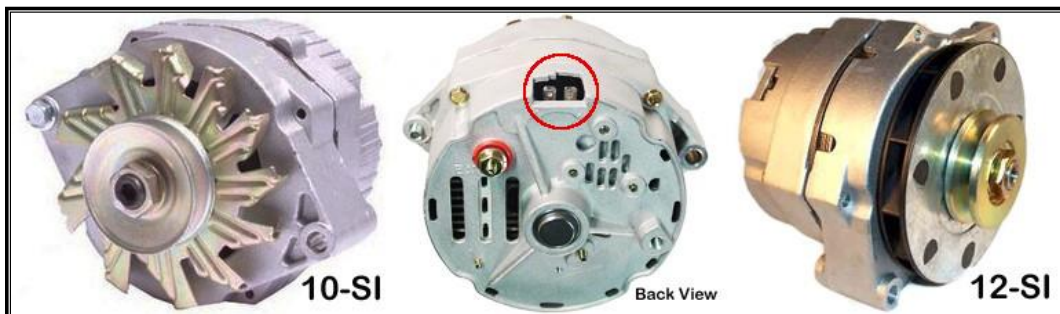

The 10-SI and 12-SI alternators are easy to identify. They have an external fan behind the pulley (the 12-SI has enclosed style fan blades) and a 2-pin connection. This 2-pin connection is circled on the second example in the image above. These are also commonly referred to as “Delco” or “Delcotron” alternators.

The two wires, **RED #995 REGULATOR POWER (BAT)** and **BROWN #914 ALTERNATOR REGULATOR POWER (IGN)** connect to the two posts on the back edge of the alternator.

- Route the two wires to the numbered 1 & 2 terminals on the alternator and cut to length. Strip $\frac{1}{4}$ " of insulation from both wires.
- A factory-style connector and terminals, seen in the photo to the right, are provided in the “ALTERNATOR” bag. Crimp a terminal onto each of the two wires.
- Insert the wires into the connector as shown in the diagram below. When the terminal pin-out is complete, plug the connector into the alternator.



You may experience engine run-on. This is caused when the alternator back feeds voltage down the **#914** wire after the key has been turned off. This allows the ignition system to still function causing the engine to continue running even though the key is turned off or even removed from the ignition. If this should happen, unplug the alternator connector to shut the engine off. If you experience this, a remedy has been provided.

As shown in the photo above and diagram below, a diode, splices, and heat-shrink are provided. If engine run-on occurs, simply install the diode as shown. When the diode is installed inline of the **#914** wire **with the stripe towards the alternator** it lets current flow towards the alternator, but not away from the alternator back-feeding the ignition system, thus fixing the run-on issue.

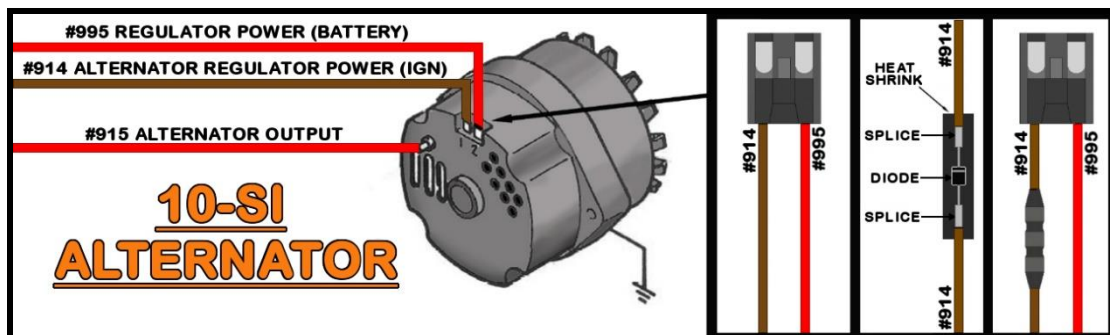

GENERAL MOTORS CS-130 SERIES ALTERNATORS

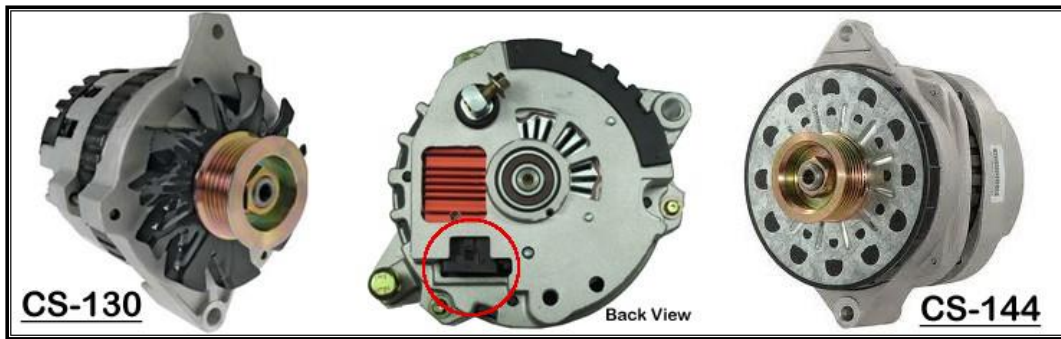

The CS-130, CS-121, and CS-144 alternators closely resemble the SI series alternators. They have an external fan behind the pulley and, generally, a plastic casing on the side and back. These alternators have a 4-pin, sealed connector, shown in the photo below and circled in the image above. The regulator will be marked P, L, S, F. This type of alternator was used on GM TPI and LT1 fuel injected engines among other late 1980s to mid-1990s GM vehicles.

The two wires **RED #995 REGULATOR BATTERY POWER** and **BROWN #914 ALTERNATOR REGULATOR POWER (IGN)**, connect to the regulator on the back of the alternator.

- Route the two wires to the connector on the alternator and cut to length. Strip $\frac{1}{4}$ " of insulation from both wires.
- The factory 4-pin alternator connector from a factory GM harness is needed. It is not included with this Painless chassis harness.
- The CS-130 alternator requires a resistance on the **BROWN #914** wire. Without this resistance, the regulator on the alternator will burn up. A resistor, splices, and heat-shrink, seen below, are provided in the "ALTERNATOR" bag kit. The resistor* will simply need to be installed inline on the **#914** wire as shown in the diagram on the next page.

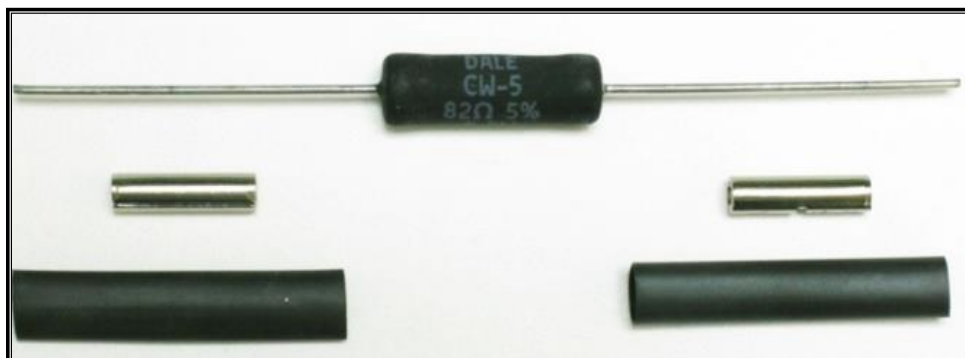
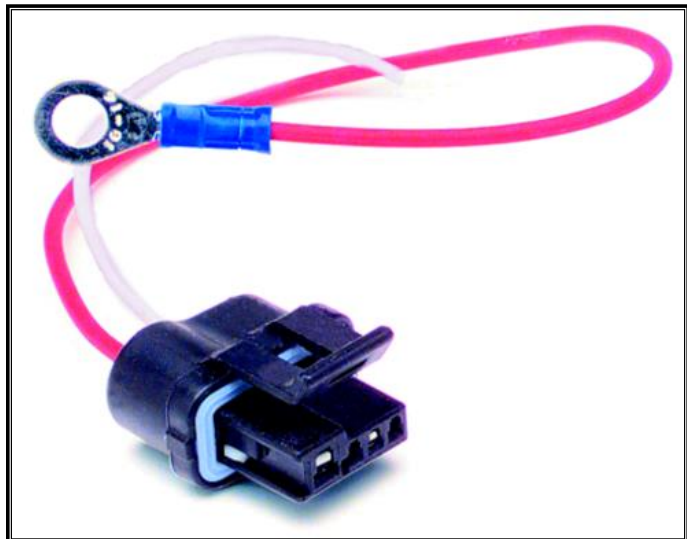

*In factory applications where this alternator was used, a charge indicator light created the necessary resistance. **For those with an instrument panel with a charge indicator light, the resistor is not needed.** However, the #914 wire needs to be routed to one side of the charge indicator light and the other side of the light then routes out to the alternator. A charge indicator light was explained in more detail on [page 53](#).

- Use 2 of the splices and heat-shrink provided in the “ALTERNATOR” bag kit to splice the CS-130 pigtail to the #914 and #995 wires according to the diagram below.

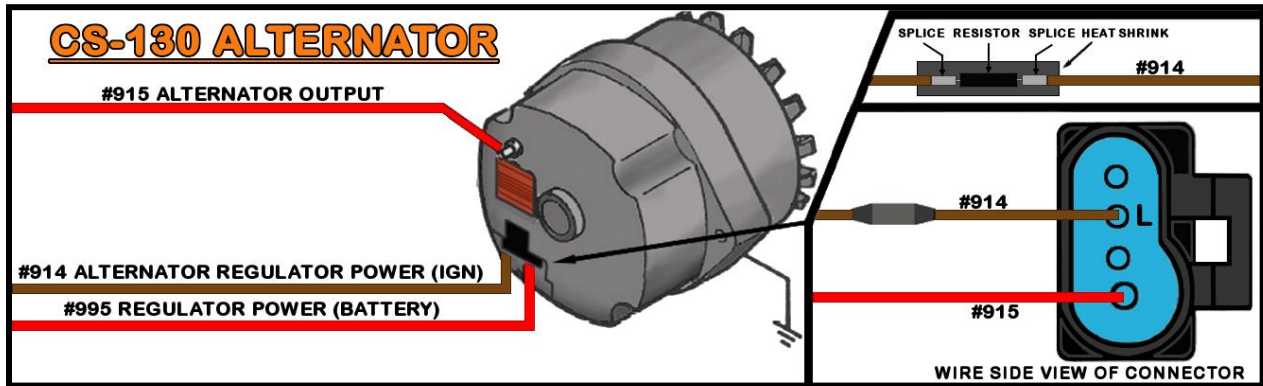

GENERAL MOTORS CS-130D SERIES ALTERNATORS

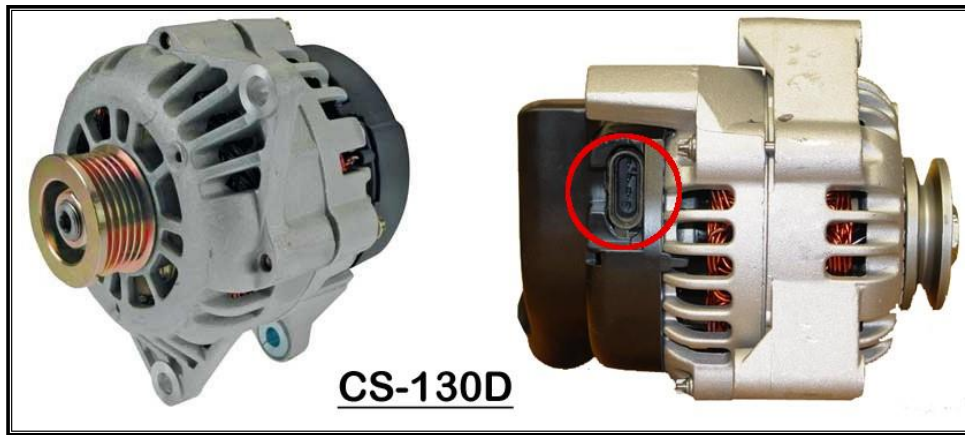

The CS-130D can be spotted by the lack of an external fan behind the pulley. These alternators have an internal fan and a plastic casing on the back. These alternators have an elongated, oval, 4-pin, sealed connector, seen circled in the image above. The regulator will be marked P, L, I, S. This type of alternator was used on many engines, including the GM LS series, Vortec, and Gen. III Vortec truck fuel injected engines.

There are two wires in the **Alternator Section**: **RED #995 REGULATOR BATTERY POWER** and **BROWN #914 ALTERNATOR REGULATOR POWER (IGN)**. For the CS-130D alternator, only the **BROWN #914** is used. The **#995** may be connected to the alternator output post or removed from the harness.

- Route the **BROWN #914** to the connector on the alternator and cut to length. Strip $\frac{1}{4}$ " of insulation.
- The factory, 4-pin alternator connector from a factory GM harness, or a CS-130D pigtail purchased from Painless (**part #30705**; see photo), needs to be used.
- The CS-130D alternator requires a switched power source to pin "I" of the regulator and a resisted power source on the wire going to pin "L" of the regulator. Without this resistance, the regulator on the alternator will burn up. A resistor, splices, and heat-shrink, seen on [page 56](#), are provided in the "ALTERNATOR" bag kit. The resistor simply needs to be installed inline on the pin "L" wire, **#914**, as shown in the diagrams on the next page.



In factory applications where this alternator was used, a charge indicator light created the necessary resistance. **For those with an instrument panel with a charge indicator light, the resistor is not needed**. However, the **#914** wire needs to be routed to one side of the charge indicator light and the other side of the light then routes out to the alternator. A charge indicator light was explained in more detail on [page 53](#).

- Using a splice and heat-shrink provided in the "ALTERNATOR" bag kit, splice the CS-130D pigtail to the **BROWN #914** wire according to one of the diagrams on the next page.

Both diagrams accomplish the same task: they use the **BROWN #914 ALTERNATOR REGULATOR POWER (IGN)** wire to provide a switched power source and a resisted power source to the 2 wires of a CS-130D alternator pigtail/connector when a charge indicator light is NOT being used. Pick the method that easiest for you to understand.

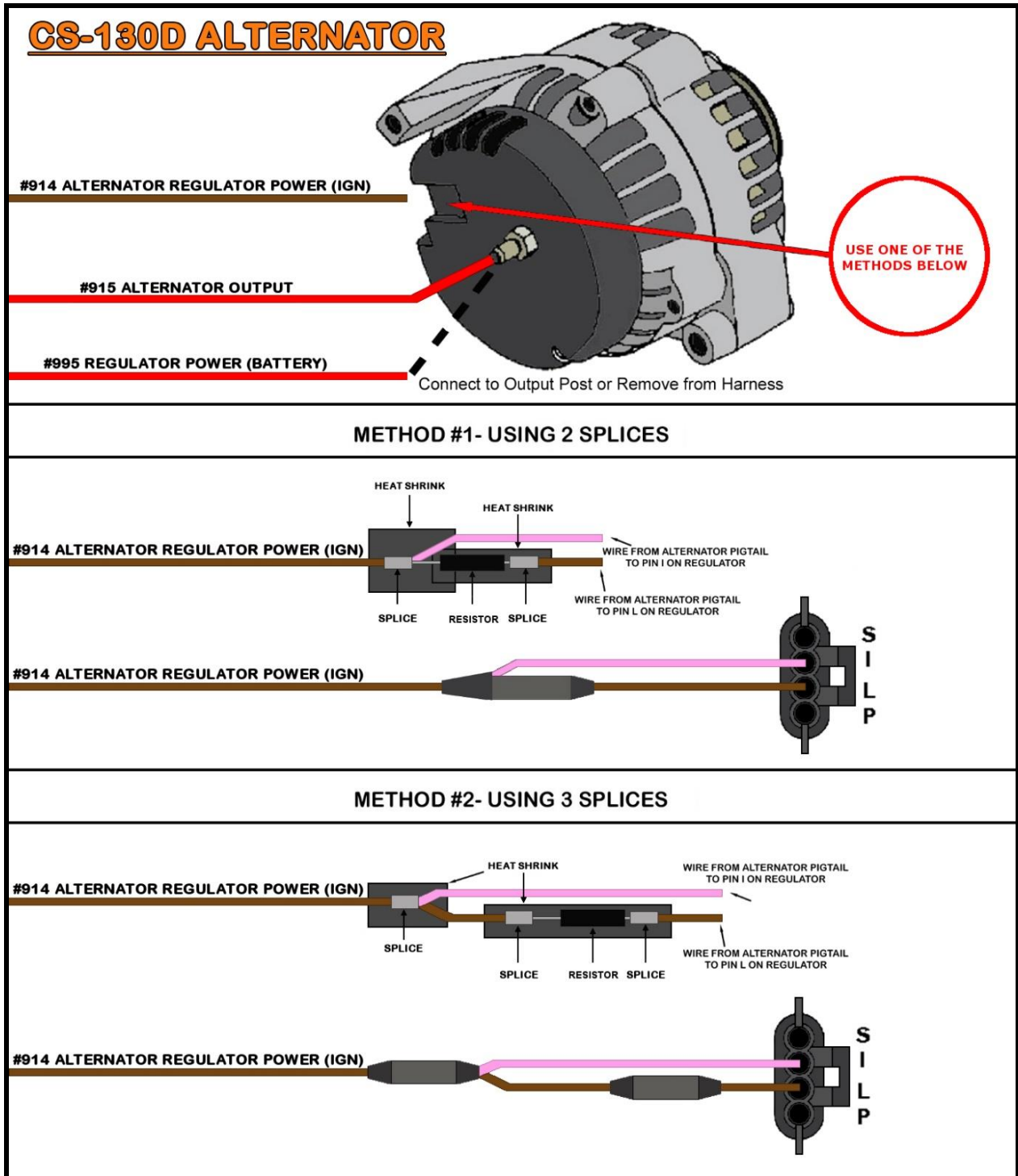

GENERAL MOTORS EXTERNALLY REGULATED ALTERNATORS

The two wires, **RED #995 REGULATOR POWER (BAT)** and **BROWN #914 ALTERNATOR REGULATOR POWER (IGN)** connect to the regulator.

- Route the two wires of the Painless harness to the connection point on the regulator, cut to length, and strip $\frac{1}{4}$ " of insulation from both wires.
- The factory, 2-pin alternator connector and 4-pin regulator connector from a factory GM harness need to be used. Due to a lack of usage by most customers, these connectors are not included with this Painless chassis harness. If you do not have these connectors, they can be obtained online, at a local auto parts store, or you can use the loose piece insulated terminals in the parts kit to make connections.
- Connect the **BROWN #914** wire to the "4" terminal on the regulator.
- Connect the **RED #995** to the "3" terminal on the regulator.

Two 14-gauge wires, which run from the regulator to the alternator, and a 14-gauge wire for a ground need to be provided by the installer to finish the connections. **These wires are not in the Painless harness.**

- Connect the "2" terminal on the regulator to the "R" terminal on the alternator. This was a white wire from the factory.
- Connect the "F" terminal on the regulator to the "F" terminal on the alternator. This was a blue wire from the factory.
- The last connection will be a wire from the "G" post on the alternator to a chassis ground source.

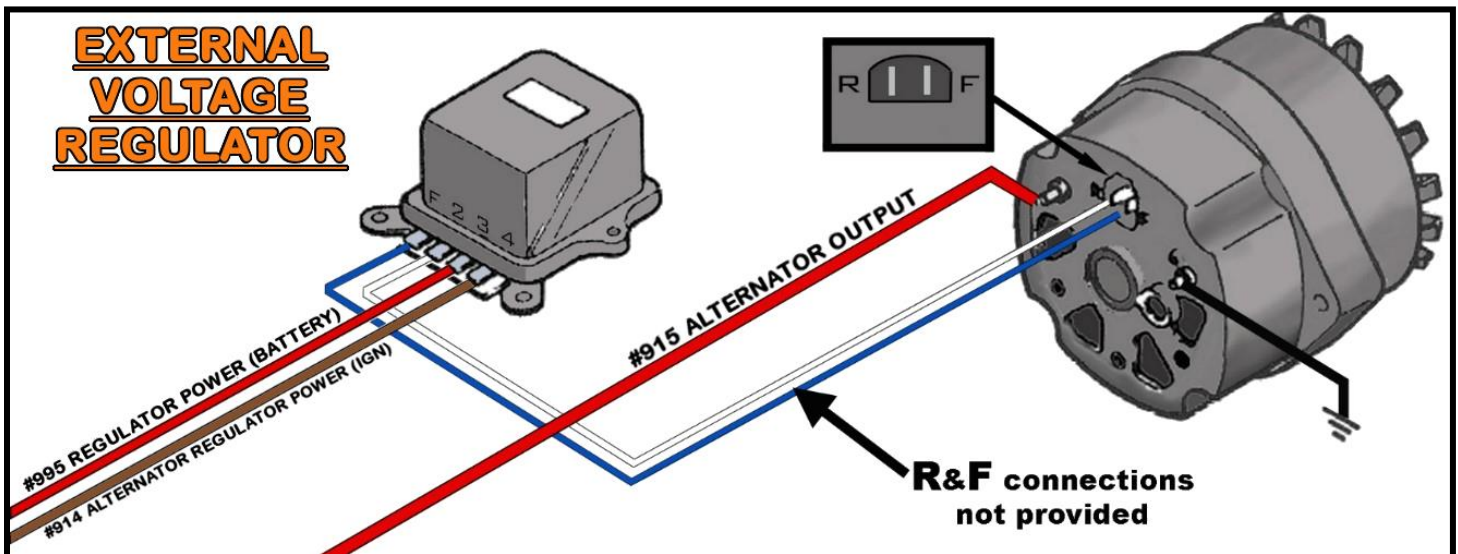

MIDI FUSE

A large, inline MIDI fuse is included in the “ALTERNATOR” bag kit. This inline fuse provides a fused link between the alternator and battery.

- Find a suitable location to mount the supplied fuse holder using the **(2) self-tapping screws** provided. A drill with a **¼” nut driver** is required to drill holes for the mounting screws.

With the fuse holder now mounted, locate the following two wires:

RED: 8-gauge wire, printed **[ENGINE SECTION] #916 BATTERY POWER SOURCE (MIDI FUSE)**, all power sources in this Painless harness originate from this wire. This wire provides battery power to the fuse block, which in turn supplies battery power to the ignition switch, which provides switched power. During normal operation, this wire always has battery power.

RED: 6-gauge wire, rolled separate from the harness, with a tag reading **#915 ALTERNATOR OUTPUT**, this wire provides power from the alternator to the battery through the MIDI fuse. See [Charge / Battery Power Schematic](#) on [page 64](#). The other end of this wire connects to the output post of the alternator.

- Route the **#915** and **#916** wires to one side of the fuse holder and cut the wires to length. **DO NOT DISCARD THE CUT OFF PORTION OF #915.**

The length of excess wire cut from the **#915** wire will be used to connect the other side of the fuse to the “+” side of the vehicle’s battery or the battery post on the starter solenoid. **DO NOT CONNECT THE #915 TO THE ACTUAL BATTERY AT THIS TIME.** If routed to the starter solenoid, this wire will NOT replace the battery cable needed by the starter from the positive side of the battery to the “BAT” or (+) post of the starter solenoid.

- Make connections to both sides of the fuse holder with the large ring terminals with the small, **#10 hole** provided with the kit. You can use a pair of pliers if your crimpers will not accept this large gauge wire/terminal. The heat-shrink supplied with this kit is intended to cover the crimped end of each of these (2) ring terminals. A schematic showing these connections can be found on [page 64](#).
- Once you install the ring terminals onto both studs of the fuse holder, the fuse can be installed, and everything can be tightened down with the two retaining nuts provided with the fuse holder. Once everything is tightened, the cover can be reinstalled. Depending on how your crimp flares the ring terminal, the cover may or may not need slight trimming to snap into place.



STARTER SOLENOID

The connections to the starter solenoid vary depending on your ignition system, the location of a neutral safety/clutch switch, and your connection point on the battery power source for the MIDI fuse.

One connection to the starter solenoid all vehicles share is:

PURPLE: 12-gauge wire, printed **[STARTER SOL.] #919 STARTER SOLENOID (START)**, this wire will supply the solenoid with a switched power source from the ignition switch. This power will activate the starter solenoid causing it to turn the engine over for startup. This wire will only have power when the ignition switch is in the *Start/Crank* position.

- **If you use a transmission mounted Neutral Safety Switch**, the **PURPLE #919** wire will need to be routed, cut to length, and connected to one side of the neutral safety switch (NSS). The cutoff portion of **#919** connects to the other side of the NSS and is then routed to the starter.
- Route the **PURPLE #919** and the ballast bypass (see [page 47](#)), if needed, to the starter solenoid and cut to length. If the remainder of **#916** from the MIDI fuse is being connected to the “BAT” or (+) post of the starter solenoid, it may be routed at this point as well. Be sure to keep all wires away from the exhaust manifold or header.
- Locate ring terminal and heat-shrink from the parts kit that best fits the posts found on the starter solenoid and install onto the wires going to the starter solenoid. Be sure to apply heat-shrink the insulation to protect the crimp.
- The **PURPLE #919** wire will connect to the “START” or “S” post on the solenoid and the bypass wire, if needed, will connect to the “I” or “R” post of the solenoid.
- If you are connecting the battery supply to the MIDI fuse to the battery cable/post on the Starter, connect it now. **BE SURE THE BATTERY CABLE IS DISCONNECTED FROM THE BATTERY BEFORE MAKING THIS CONNECTION.**

4L60e/4L80e Switch

The 4L60e/4L80e transmission, from trucks or SUVs, has a factory reverse switch on the shift detent rod located on the driver's side of the transmission. This same switch also has a park/neutral switch incorporated. Use the diagrams below to connect the reverse wires of the Painless harness to this switch. The Reverse Switch wires should have been routed into the engine compartment, through the bulkhead, on [page 17](#).

For those with a 4L60e/4L80e transmission, a starter relay must be used (not supplied) unless you use a factory switch (see [page 87](#)) on a GM Keyed column. The switch is not capable of handling the amperage the solenoid requires.

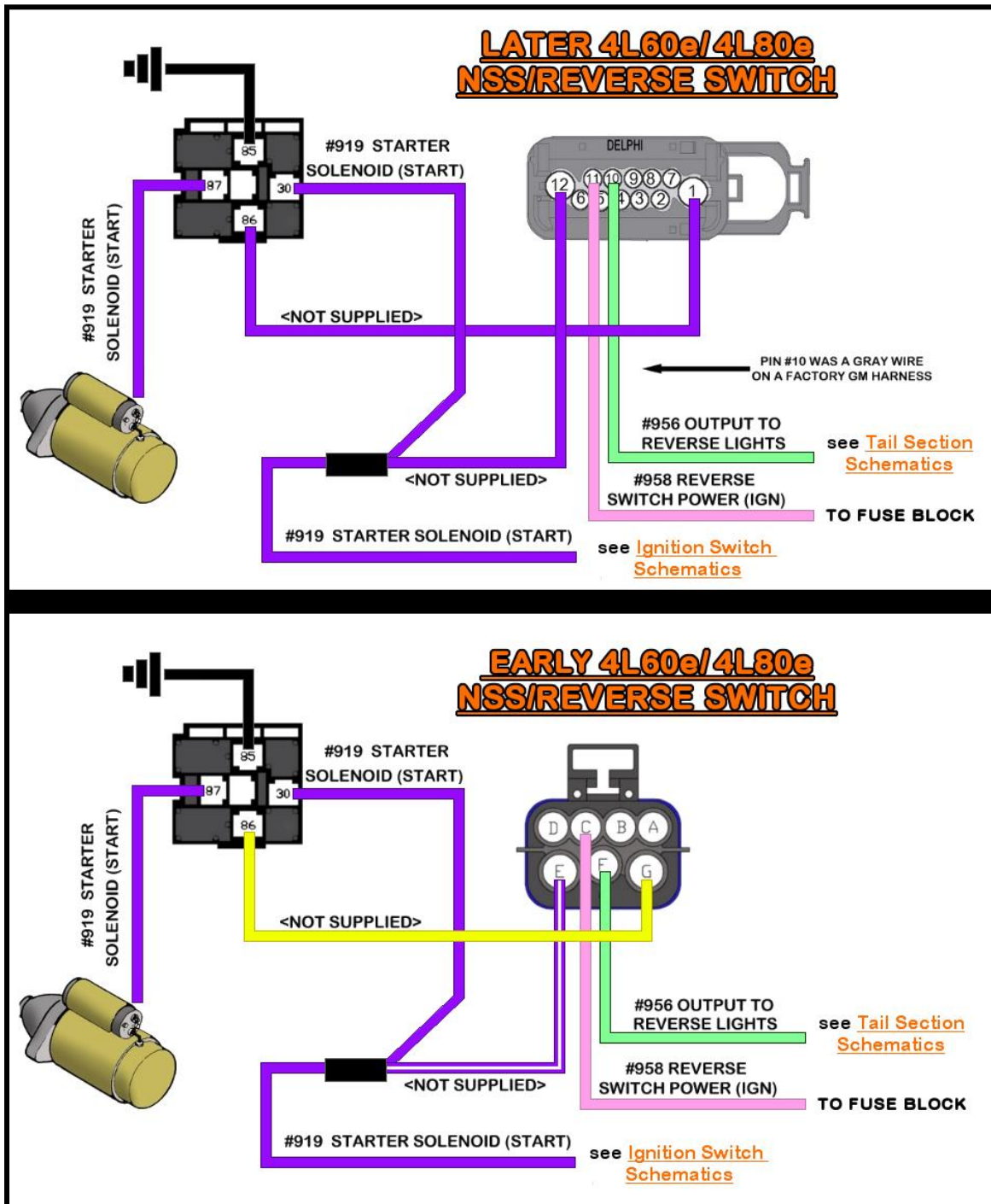

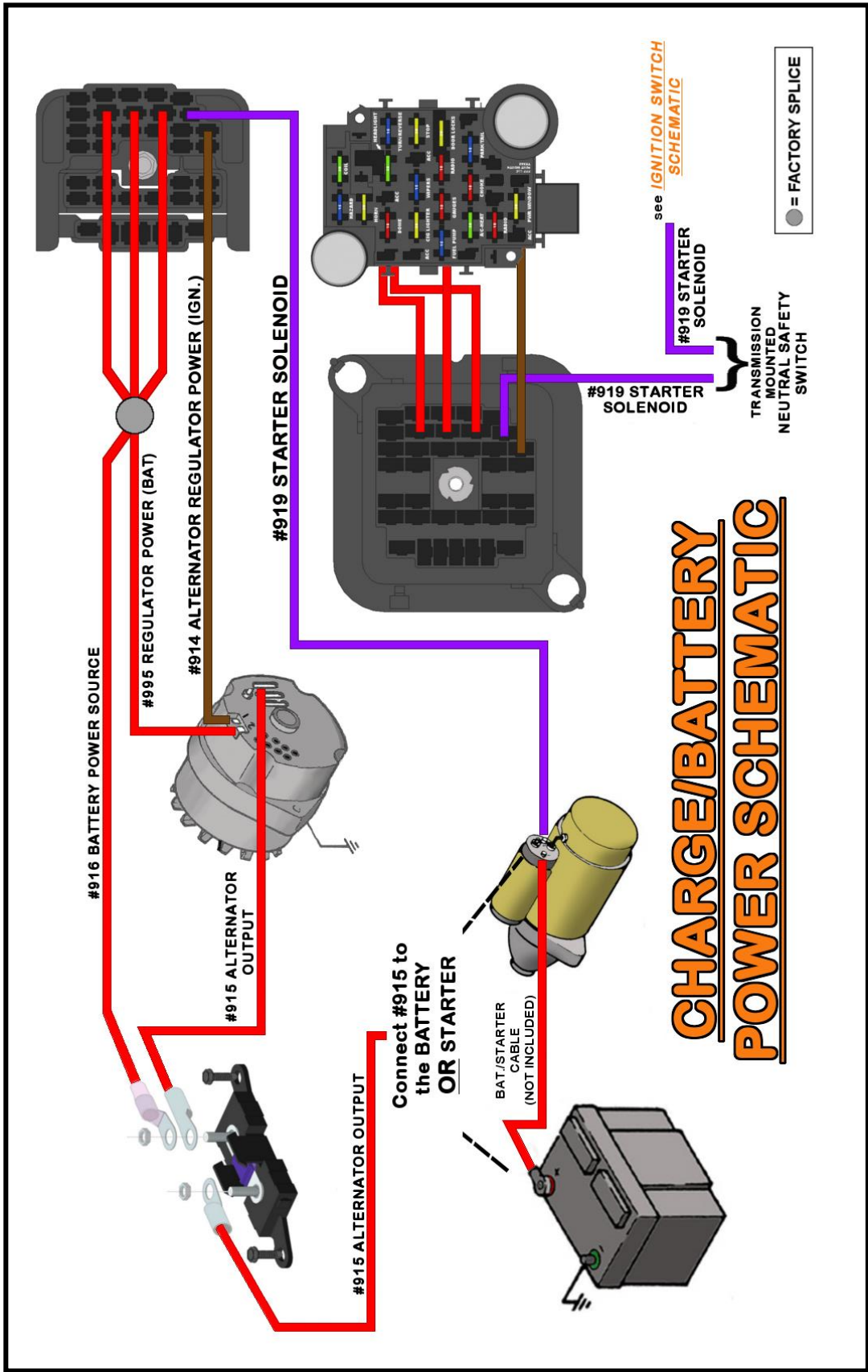

INTERIOR HARNESS

Now that the Engine Harness is wired, move to the interior of the vehicle.

Before you make any connections on the inside of the vehicle, let us address the component switches: like the headlight switch, brake switch, turn signal switch, ignition switch, and headlight/dimmer switch.

With older vehicles and hot rods in general, many times switches are replaced by what is available or what previous owners had lying around. In some cases, these switches are not marked and there is no idea what pins on the switch controls each function. If you are unsure about the positions or functionality of the switches currently in your vehicle and are not up to the task of figuring out what each pin does, Painless offers several solutions. We have switch kits and sell switches individually.

For those using a **10414** harness, a common switch kit that many people choose is **Painless part #80121**. This kit provides you with a new headlight switch, new dimmer switch, door jamb switches, and new ignition switch. All our switches are marked with each terminal's function. Part numbers for individual switches are given in each section.



DIMMER SWITCH

The first connection is the group of three wires that belong to the **Dimmer Switch Section**. These three wires provide power to the headlights for low beam and high beam power. These wires can be seen in the [Headlight Dimmer Switch Schematic](#) on [page 72](#). They are:

BLUE/YELLOW: 14-gauge wire, printed **[DIMMER SWITCH] #907 DIMMER SWITCH [HEADLIGHT SWITCH]**, this wire provides power to the dimmer switch from the headlight switch. This wire has power whenever the headlight switch is in the "HEADLIGHT ON" position.

TAN: 14-gauge wire, printed **[DIMMER SWITCH] #909 LOW BEAM**, this wire provides power from the dimmer switch to the low beams, as seen in the [Front-Lighting Section Schematic](#) on [page 37](#). Once connected, this wire has power when the headlight switch is in the "HEADLIGHT ON" position and the dimmer switch is in the "LOW BEAM" position.

LT. GREEN: 14-gauge wire, printed **[DIMMER SWITCH] #908 HIGH BEAM**, this wire provides power from the dimmer switch to the high beams. This wire doubles at the bulkhead with **LT. GREEN #936** which provides power to the high beam indicator. Once connected, this wire has power when the headlight switch is in the "HEADLIGHT ON" position and the dimmer switch is in the "HIGH BEAM" position.

The connection point of these wires depends on the location of the dimmer switch. Most have a floor-mounted dimmer switch, although, those using a later model GM column may find the dimmer switch on the side of the column.

- Route all 3 wires to the dimmer switch and cut to length.
- Connect the three wires to the dimmer switch as shown in the diagram on the next page.

For those using a GM style switch, either column or a floor-mounted like [Painless part #80150](#), a connector and terminals have been provided.



HEADLIGHT DIMMER SWITCHES

GM COLUMN MOUNTED

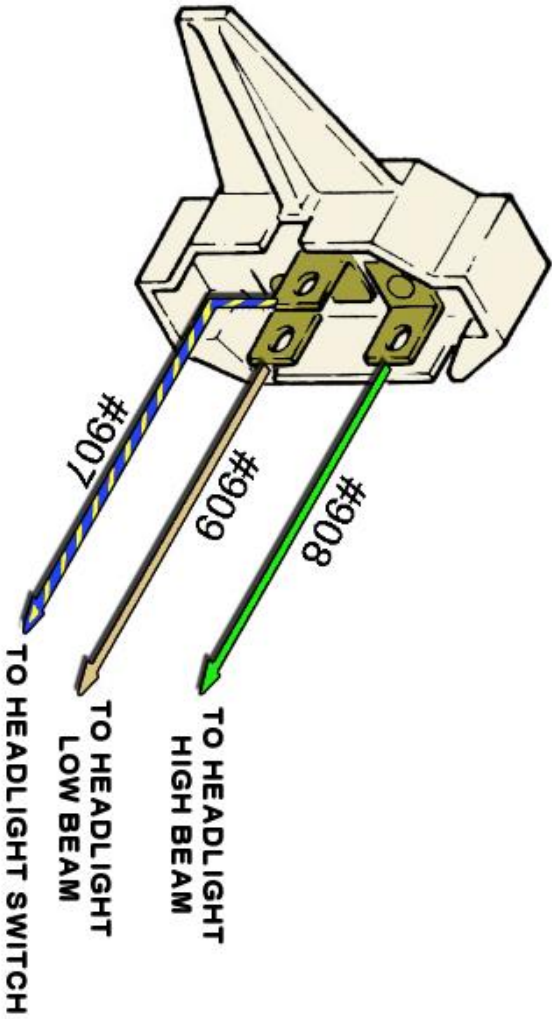

GM FLOOR MOUNTED

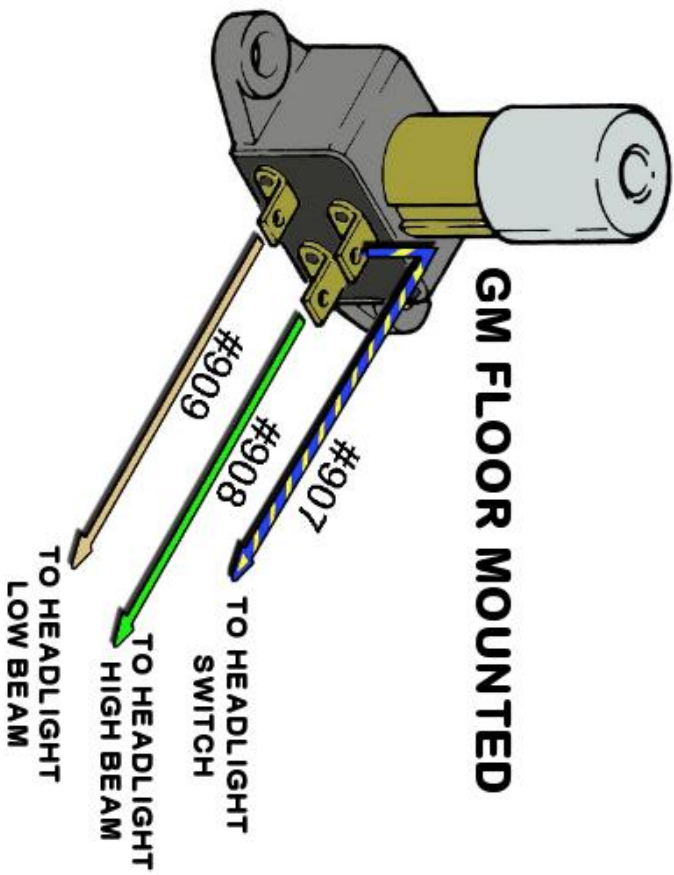

DRIVER COURTESY LIGHT SECTION

The Courtesy Light Section has 4 wires, and connections in this section lead to both sides of the vehicle. Therefore, it is easiest to wire the passenger side after working your way across the dash. So, Passenger Side Courtesy Lights are covered on [page 105](#).

DRIVER DOOR JAMB SWITCH

The door jamb switches provide a ground activation for the courtesy lights and dome light. When the door is opened, the plunger on the switch extends out as it is no longer being pushed in by the door. When the plunger extends, the contact point on the back of the switch contacts the body of the switch, which is grounded through the mounting into the metal door jamb. This grounding gives the wire attached to the switch a ground source which will then cause the interior lights to turn on.

Locate the wire in the courtesy light section intended for the driver door jamb switch. It is:

WHITE: 18-gauge wire, printed [**COURTESY LIGHT**] **#961 DRIVER SIDE DOOR JAMB SWITCH**, this wire is spliced to other white wires leading to the dome light, courtesy light, headlight switch, and the passenger side door jamb switch. This wire is grounded anytime either door is opened, or when the headlight switch knob is rotated to the "DOME LIGHT ON" position. This wire can be seen in the [Dome / Courtesy Light Schematic](#) on [page 70](#).

- Route the **WHITE #961** wire to the driver side door jamb switch and use an insulated terminal from the parts kit that fits your switch to connect it. If you find that your door jamb switch has 2 tabs, it does not matter which tab the **#961** connects to.

If this is a new build/restoration or your original switches are just in bad shape and new switches are needed, Painless offers factory style GM jamb switches as [part #80170](#). Please note that [part #80170](#) is for 1 switch, and each door requires a switch.

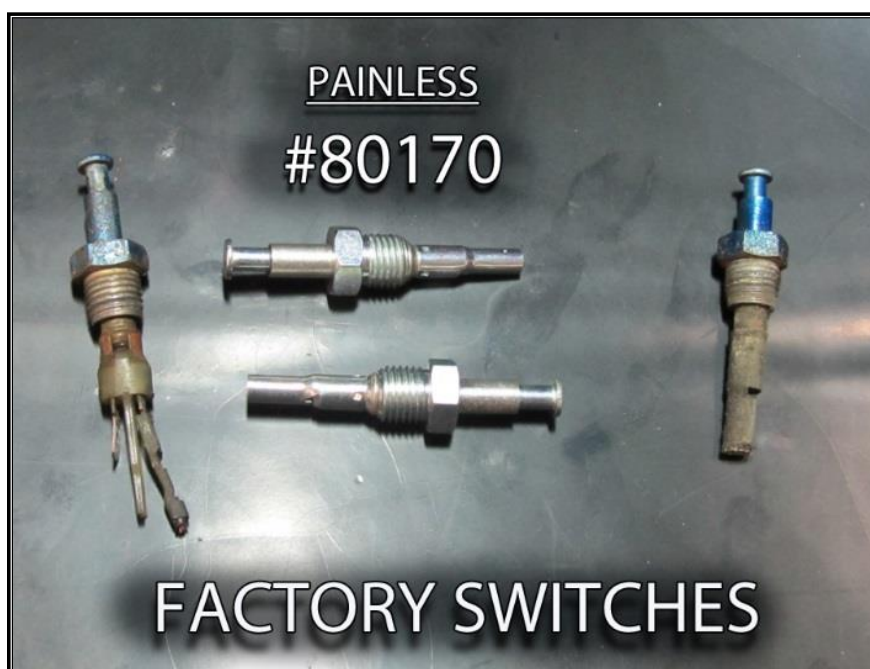

DRIVER COURTESY LIGHT

This connection allows the driver side under the dash/floorboard of the vehicle to be illuminated any time a door is open or when the headlight switch is activating the dome light.

These wires can be seen in the [Dome/Courtesy Light Schematic](#) on the next page, these wires are:

ORANGE: 18-gauge, printed [**COURTESY LIGHT**] #971 **COURTESY LIGHT POWER (BAT)**, this wire provides power from the 10-amp DOME fuse on the fuse block. This fuse is battery powered and always has power.

WHITE: 18-gauge, printed [**COURTESY LIGHT**] #961 **COURTESY LIGHT GROUND**, this is the ground wire that activates the courtesy light. When this wire is grounded, it completes the voltage path and causes the light to illuminate. This ground comes from either of the door jamb switches, if the door is opened, or the headlight switch when it is turned to the "DOME LIGHT ON" position.



- Locate a lamp socket and terminals from the parts kit (pictured above). This light socket can use either a 63 or 67 series bulb.
- Locate a suitable mounting location under the driver's side of the dash. The light socket has a small hole in a mounting tab to allow mounting. This kit provides both self-tapping screws and small zip-ties to accommodate the various ways you might affix the socket. You may also use screws that hold existing trim. **Do not mount the socket at this time.**
- Route the wires to where the socket will be mounted and cut to length. Retain the cutoff wires as they will be doubled up with the terminals at this socket and routed to the passenger side for the passenger side courtesy light.
- Strip $\frac{1}{4}$ " of insulation from each wire and install the terminals. Crimp the smaller, brass terminal to the **WHITE** #961 wire and the larger terminal to the **ORANGE** #971 wire.
- Insert the terminals into the connector, install a #67 bulb (not included), and mount the socket. Once mounted, route the cut off pieces of #971 and #961 to the passenger side of the vehicle or the center console if you have a courtesy light on the back of the console.

DOME/COURTESY LIGHT SCHEMATIC

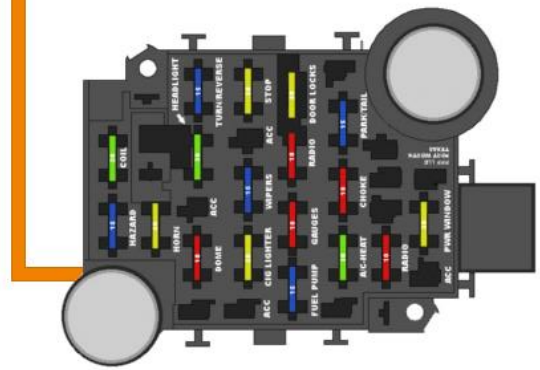

FUSE BLOCK

● = FACTORY SPLICE

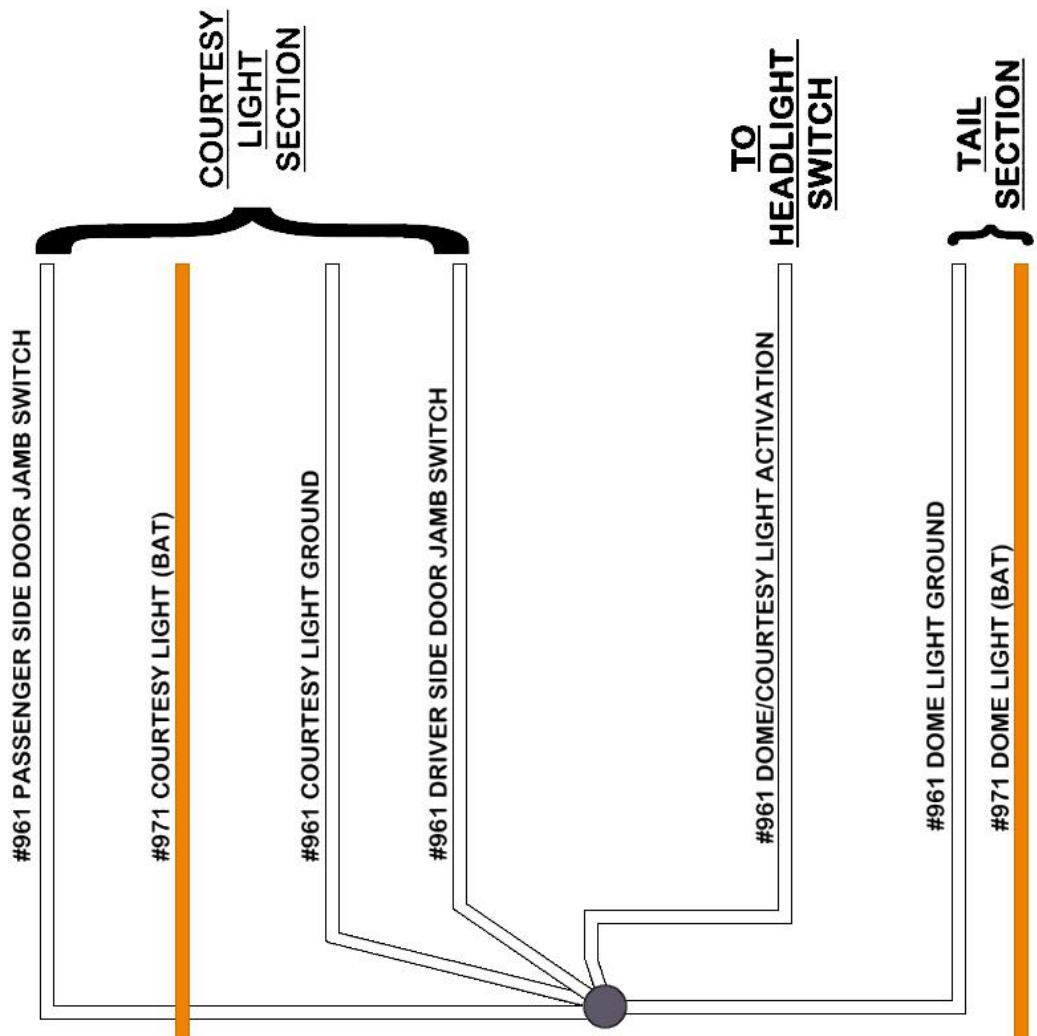

HEADLIGHT SWITCH

The headlight switch's connections send power to the headlights, front park/marker lights, rear taillights, and component backlighting, such as gauges and the radio. These wires can be seen in the [Headlight Switch & Dimmer Switch Schematic](#) on the next page. These seven wires are:

ORANGE: 14-gauge wire, printed **[HEADLIGHT SWITCH] #959 HEADLIGHT SWITCH POWER (BAT)**, this wire supplies constant battery power for the park/taillights as well as for the gauge backlighting. This wire comes from the 15-amp PARK/TAIL fuse on the fuse block.

BROWN: 18-gauge wire, printed **[HEADLIGHT SWITCH] #927 FRONT PARK LIGHTS**, this wire supplies power to the park lights. This wire has constant battery power any time the headlight switch knob is pulled to Park Light ON and, depending on your switch, the Headlight ON position.

BROWN: 16-gauge wire, printed **[HEADLIGHT SWITCH] #929 TAILLIGHTS**, this wire supplies power to the taillights. This wire has constant battery power any time the headlight switch knob is pulled to both the park light ON and headlight ON positions.

BLUE/YELLOW: 14-gauge wire, printed **[DIMMER SWITCH] #907 DIMMER SWITCH POWER [HEADLIGHT SWITCH]**, this wire supplies power to the dimmer switch for headlight operation. This wire has constant battery power any time the headlight switch knob is pulled to the headlight ON position.

GREEN: 16-gauge wire, printed **[HEADLIGHT SWITCH] #930 GAUGE/PANEL LIGHTING**, this wire provides power to the gauge lights. This wire should have constant battery power any time the headlight switch knob is pulled to both the park light ON and headlight ON positions.

RED: 12-gauge wire, printed **[HEADLIGHT SWITCH] #928 HEADLIGHT SWITCH POWER (BAT)**, this wire provides constant battery power to the headlight switch for headlight operation. This wire comes from the 30-amp HEADLIGHT fuse on the fuse block.

WHITE: 18-gauge wire, printed **[HEADLIGHT SWITCH] #961 DOME/COURTESY LIGHT ACTIVATION**, this wire provides a ground source for the interior dome/courtesy lights.

- Route the wires to the headlight switch and connect them. A connector and terminals, seen on [page 73](#), have been provided in the parts kit for those with a factory GM switch.

The use of some or all these wires will depend on the headlight switch you use. Factory style switches will use all wires, whereas most universal switches may not require all of them. Diagrams have been provided of the most common switches, along with universal switches that Painless also offers.

GM HEADLIGHT SWITCH

Use the following diagrams to connect to a GM style headlight switch. GM used this style headlight switch from the 1960s up through the 1980s. There are 2 different types of these switches, commonly referred to as early and late styles. The only difference is the tab to which the park lights connect (see the diagrams below for an illustration of this difference). Painless offers the early style switch with a headlight pull, [part #80152](#), seen in the photo to the right.

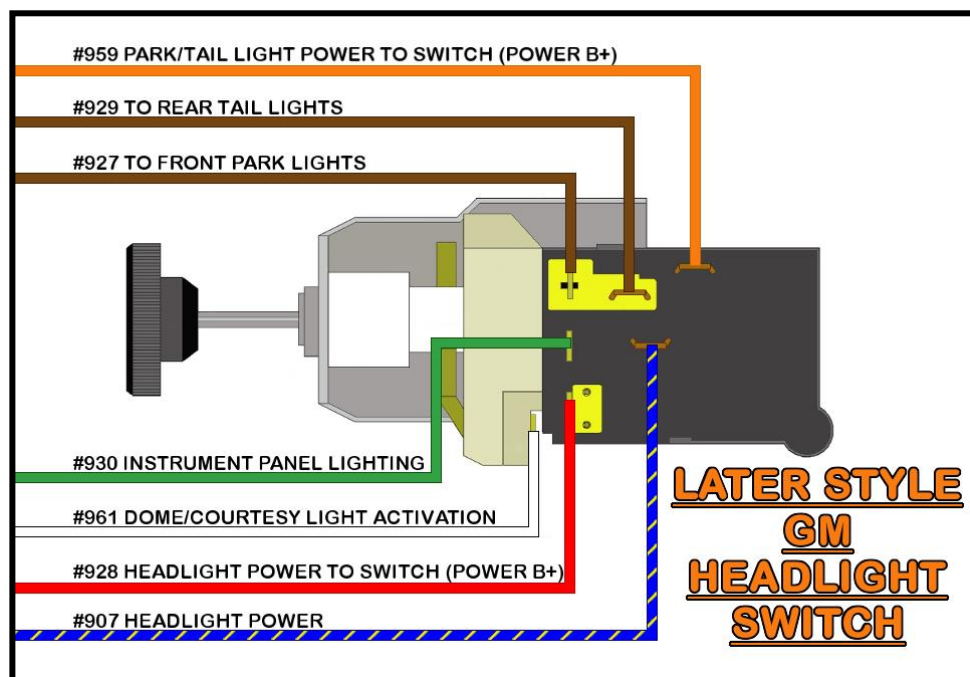
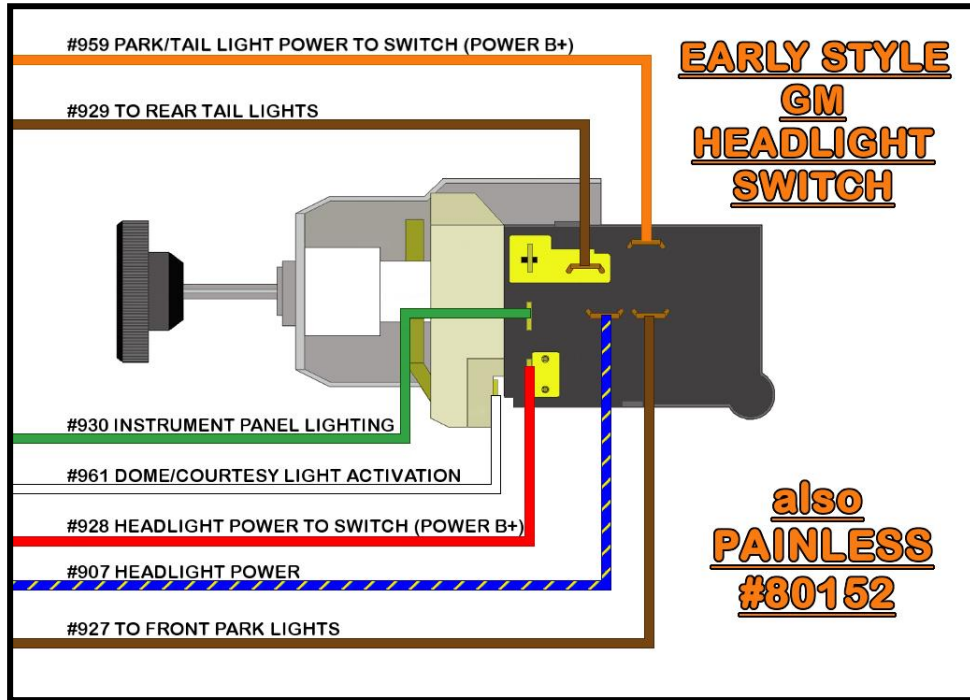

PAINLESS UNIVERSAL HEADLIGHT SWITCHES

Painless offers several universal switches as well, and even one with hi-low beam dimmer functions. Use the following diagrams to connect to either of the universal headlight switches offered by Painless. Use the blue insulated ring terminals found in the parts kit to make these connections.

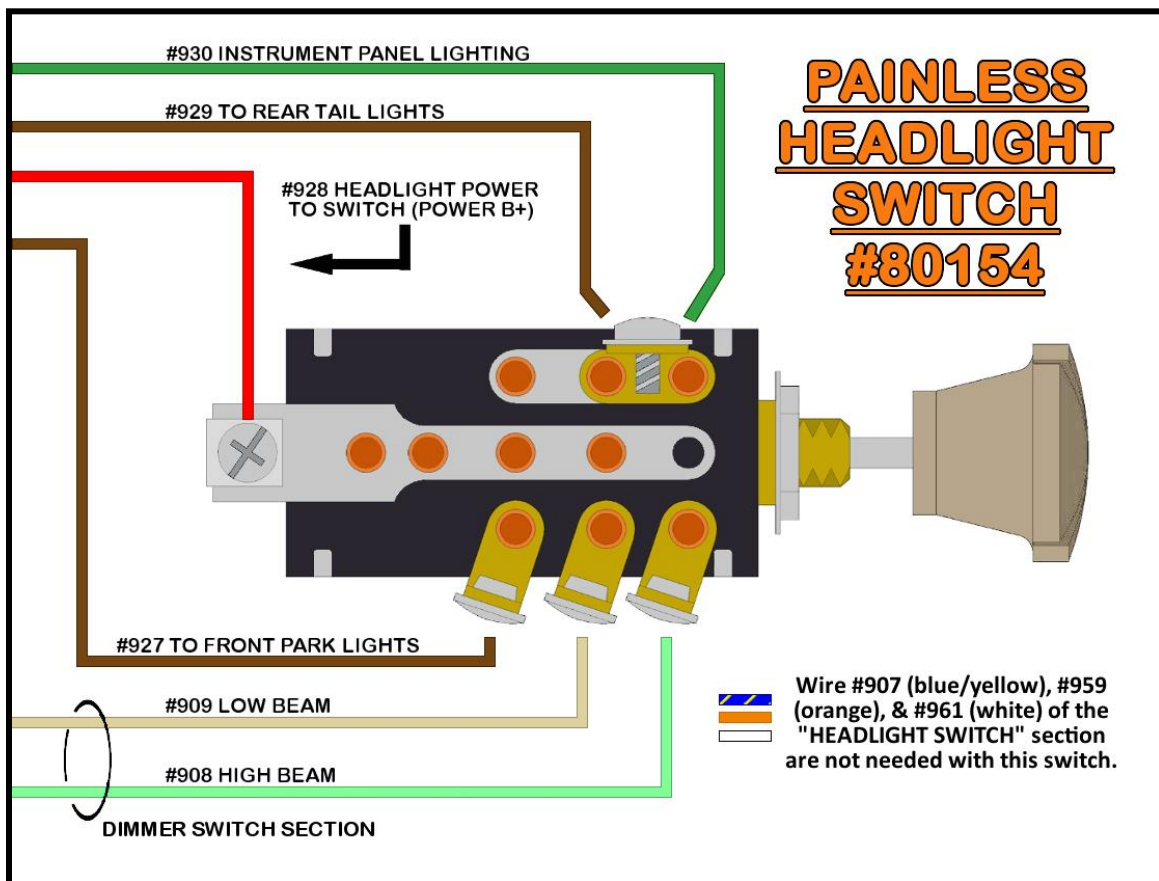
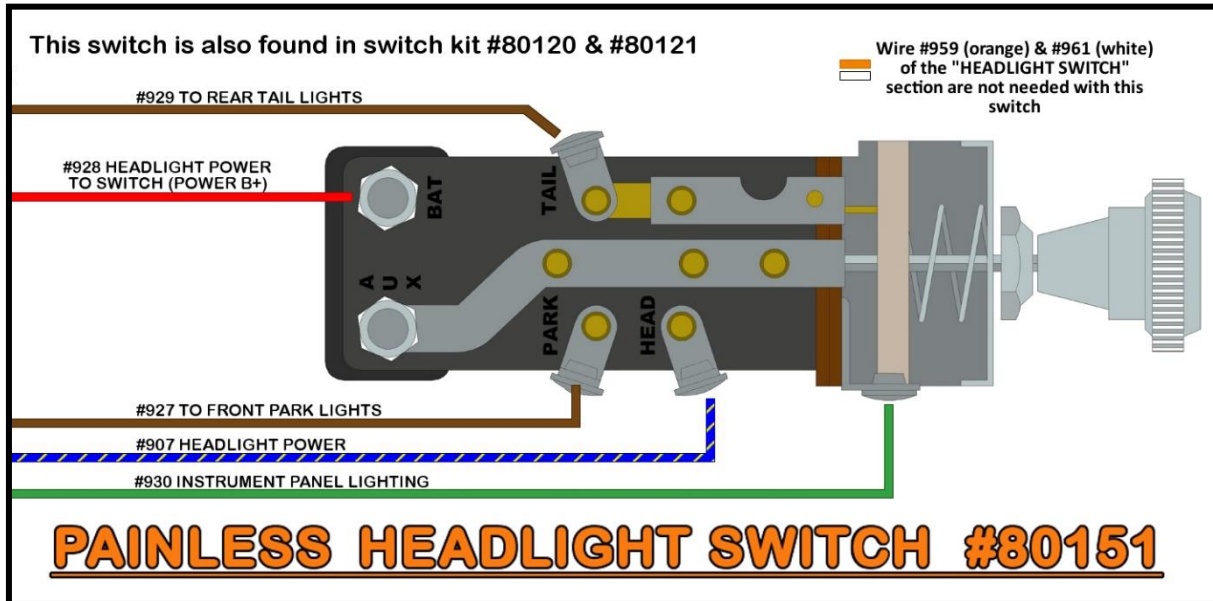

WIPER SWITCH

The **Wiper Switch Section** consists of wires that run directly between the switch and the motor. If you do not have a wiper system, these wires can be removed from the harness. In addition to the 3 wires already in the harness, you may also need the **YELLOW #905** wire from the **Accessory Section** for wiper power. This wire should have been routed to the motor or switch on **page 17**. If you do not have a wiper system, this wire can be used to power some other accessory so long as the max amperage does not exceed 10 amps. As it comes, the **Wiper Switch Section** provides the wires for most 2-speed systems. Additional wires, not supplied, will need to be added for those with a 3-speed or intermittent systems.

YELLOW: 16-gauge wire, printed **[ACC. SECTION] #905 WIPER SWITCH POWER (IGN)**, this wire supplies switched ignition power to the wiper motor/switch from the 15-amp WIPERS fuse on the fuse block.

The following wires either provide power or ground to the wiper motor from the switch. This will depend on the connection of the **YELLOW #905** wire. If your wiper motor requires an ignition switched, 12v source directly from the fuse block, like most firewall-mounted GM motors, the **#977**, **#979**, and **#984** will provide ground to the motor.

LT. BLUE: 18-gauge wire, printed **[WIPER MOTOR] #977 HIGH [WIPER SWITCH]**.

BLACK: 18-gauge wire, printed **[WIPER MOTOR] #979 LOW/PARK [WIPER SWITCH]**.

BLUE: 18-gauge wire, printed **[WIPER MOTOR] #984 WASHER PUMP [WIPER SWITCH]**.

- Route the wires to the wiper switch, cut to length, and strip $\frac{1}{4}$ " of insulation from the wires
- Refer to your factory harness or schematic for the correct switch pinout.
- The parts kit provides single-pin connectors and terminals for connection to the switch.



NOTES:

BRAKE SWITCH

The location of the brake switch varies from vehicle to vehicle as this connection depends on the style switch your vehicle uses.

Hydraulic switches, like [Painless part #80171](#), are mounted in the engine compartment, usually near or on the master cylinder. A mechanical switch, like [Painless part #80172 \(2-pin\)](#) or [#80176 \(4-pin, also included in our torque converter lockup kits #60109 & #60110\)](#), will be mounted on or near the pivot point of the brake pedal.



There are two wires found in the Painless chassis harness for proper brake switch connection, and they are:

ORANGE: 16-gauge wire, printed **[BRAKE SWITCH] #917 BRAKE SWITCH (BAT)**, which provides power from the 20 amp STOP fuse. This wire always has power.

WHITE: 16-gauge wire, printed **[BRAKE SWITCH] #918 BRAKE SWITCH OUTPUT**, this wire supplies power from the brake switch to the brake lights. The wire goes into a splice with 2 other wires, which can be seen in the [Turn Signal Switch & Brake Switch Schematic](#) on [page 81](#).

- Route the brake switch wires to the brake switch and connect them using the connector provided or the loose insulated terminals provided in the parts kit. Be sure to route the wires away from the moving parts of the brake pedal and/or clutch pedal.
- Terminals and a connector, as shown, are provided for those with a factory, GM, pedal mounted switch.



If your brake switch has four connection pins:

- Two pins will have contact (closed) when the brakes are not applied. This is usually the pair of terminals closest together. These pins are for cruise control and/or torque converter lockup.
- Two pins will be separate (open) when the brakes are not applied. This is usually the pair of terminals further apart. You will need the two posts that are normally open for brake light function.

TURN SIGNAL SWITCH

The turn signal switch provides power to each turn signal and turn signal indicator. For those using a later model or aftermarket GM style column, turn signal switch connectors are provided. As noted on [page 10](#), if you use LED lights, a no-load flasher is required ([Painless part #80230](#)).

In this group of instructions, you will see the term “integrated turn/brake lights.” Most vehicles have integrated lights. This terminology refers to turn signals that also function as brake lights. You can easily tell if your vehicle has integrated turn/brake signals or separate turn/brake lights by looking at the lamp socket(s) on the rear of the vehicle. Only looking at the passenger or the driver side, how many sockets going into red lenses do you see?

Integrated turn/brake signal vehicles will usually have 1 socket per side with a dual filament bulb (brighter filament for turn/brake, the dimmer filament for taillights). You can also have vehicles that have integrated lights but also have multiple sockets and lenses.



Separate turn/brake signal vehicles will usually have 2 or 3 sockets: 1 socket with dual filaments (brighter filament for brake, dimmer for tail) and 1 socket with a single filament for the turn signal. Remember to count the bulb filaments or the contacts on the bottom of the bulb, not the wires going to them, as your sockets may or may not have ground wires.



The wires provided in the Painless harness for turn signal connection can be identified by the wires reading "TURN SWITCH." These wires can be seen in the [Turn Signal Switch & Brake Switch Schematic](#) on [page 81](#), they are:

BLACK: 18-gauge wire, printed **[TURN SIGNAL SWITCH] #963 HORN RELAY GROUND ACTIVATION**, this wire is a ground activation signal to the horn relay. The only time this wire is grounded is when the horn button on the steering wheel makes contact to a ground source.

LT. BLUE: 16-gauge wire, printed **[TURN SIGNAL SWITCH] #926 LEFT FRONT TURN SIGNAL**, this wire provides power to the front left turn signal. This wire has power anytime the hazard switch is activated or when the turn signal lever is in the down/left turn position and the ignition switch is in the ON/RUN position.

LT. BLUE: 18-gauge wire, printed **[INTRUMENT PANEL SECTION] #937 LEFT TURN INDICATOR**, this wire sends a 12V signal to the left turn indicator when the turn signal switch is in the down/left turn position. On **10413** harnesses only, this wire will be doubled with the **LT. BLUE #926** wire at the Turn Signal Switch. For those using the **10414** harness, this wire doubles with the **LT. BLUE #926** wire at the bulkhead and does not connect to the turn signal switch.

BLUE: 16-gauge wire, printed **[TURN SIGNAL SWITCH] #925 RIGHT FRONT TURN SIGNAL**, this wire provides power to the front right turn signal. This wire has power anytime the hazard switch is activated or when the turn signal lever is in the up/right turn position and the ignition switch is in the ON/RUN position.

BLUE: 18-gauge wire, printed **[INTRUMENT PANEL SECTION] #938 RIGHT TURN INDICATOR**, this wire sends a 12V signal to the right turn indicator when the turn signal switch is in the up/right turn position. On **10413** harnesses only, this wire will be doubled with the **BLUE #925** wire at the Turn Signal Switch. For those using the **10414** harness, this wire doubles with the **BLUE #925** wire at the bulkhead and does not connect to the turn signal switch.

BROWN: 16-gauge wire, printed **[TURN SWITCH] #951 HAZARD SWITCH POWER (BAT)**, this wire provides power to the hazard switch. It comes from the hazard flasher found on the fuse block. It is a battery power wire, but it has power only when the hazard switch is activated which causes the flasher to send power through this wire. See [Flashers](#) on [page 10](#) for how this process works.

PURPLE: 16-gauge wire, printed **[TURN SWITCH] #952 TURN SIGNAL SWITCH POWER (IGN)**, this wire provides power to the turn signal switch. It comes from the turn signal flasher found on the fuse block. It is an ignition power wire, but it has power only when the turn signal switch is activated, which causes the flasher to send power through this wire. See [Flashers](#) on [page 10](#) for how this process works.

YELLOW: 16-gauge wire, printed **[TAIL SECTION] #949 LEFT TURN/BRAKE**, this wire provides power to the left rear turn signal. This wire has power anytime the hazard switch is activated and when the turn signal lever is in the down/left turn position and the ignition switch is in the ON/RUN position. On vehicles with integrated turn/brake lights, this wire also carries the brake light power wire. In those cases, this wire will also have power anytime the brake pedal is pressed.

GREEN: 16-gauge wire, printed **[TAIL SECTION] #948 RIGHT TURN/BRAKE**, this wire provides power to the right rear turn signal. This wire has power anytime the hazard switch is activated and when the turn signal lever is in the up/right turn position and the ignition switch is in the ON/RUN position. On vehicles with integrated turn/brake lights, this wire also carries the brake light power wire. In those cases, this wire will also have power anytime the brake pedal is pressed.

WHITE: 16-gauge wire, printed **[TURN SWITCH] #918 BRAKE SWITCH INPUT**, this wire feeds the brake light power into the turn signal switch for vehicles with integrated turn/brake signals. This wire has power anytime the brake pedal is pressed. **Those with separate turn and brake lights will not need this WHITE #918 wire.**

- Route the turn signal wires to the turn signal switch and cut to length if terminals are not pre-installed.
- A factory schematic for your vehicle may be needed to figure out your connections.

GM COLUMNS / AFTERMARKET GM STYLE COLUMNS

- Locate the black connectors in the kit that fit your column. Those with a **10414** harness without terminals pre-installed also need to locate the terminals in the bag kit. Most columns will use the plug, seen to the right, found on most aftermarket columns, as well as GM columns from the mid-1970s onward. These GM columns are a popular retrofit item because of their key on the column and tilt function.



- Using the diagram on the next page, pin each wire into its correct location on the connector. Remember, **WHITE #918** will only be connected if you have integrated lights.

- If you use the connector, once all wires have been installed, fold the locking tab down onto the connector. It will click/snap and lock the terminals in their place.
- Connect the now installed connector onto the connector on the steering column.



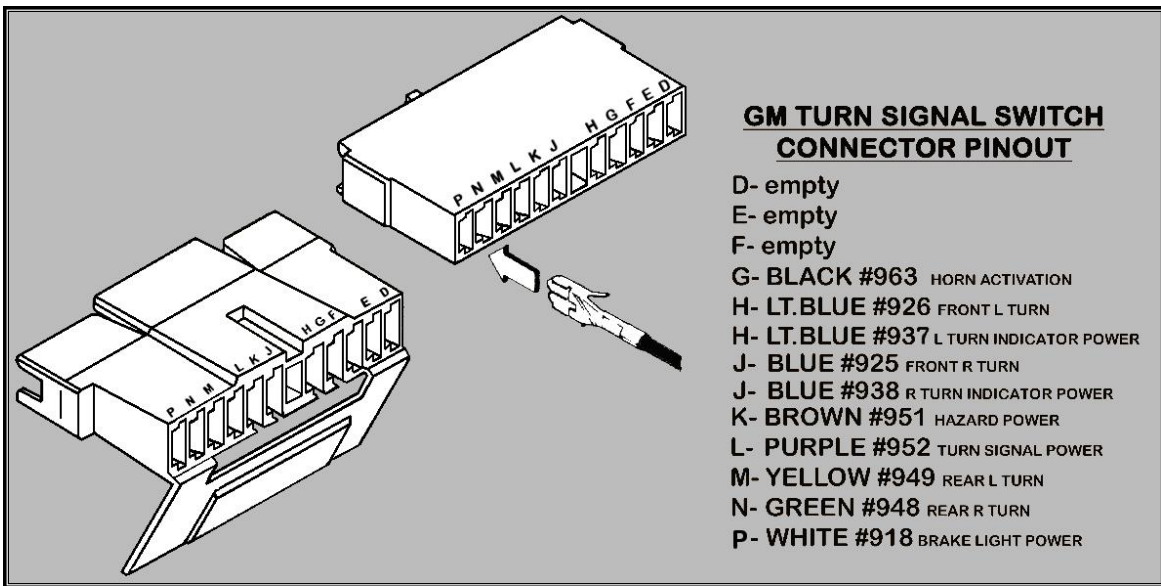

- Those with a factory 1968 or earlier columns, terminals, as shown below, are provided for you to reuse the factory “semi-circle” turn signal connector from the old harness. This is done by using a small flat screwdriver or stiff piece of wire and flattening the locking tangs on both sides of the terminal to remove them from the connector, as shown in the photos below.

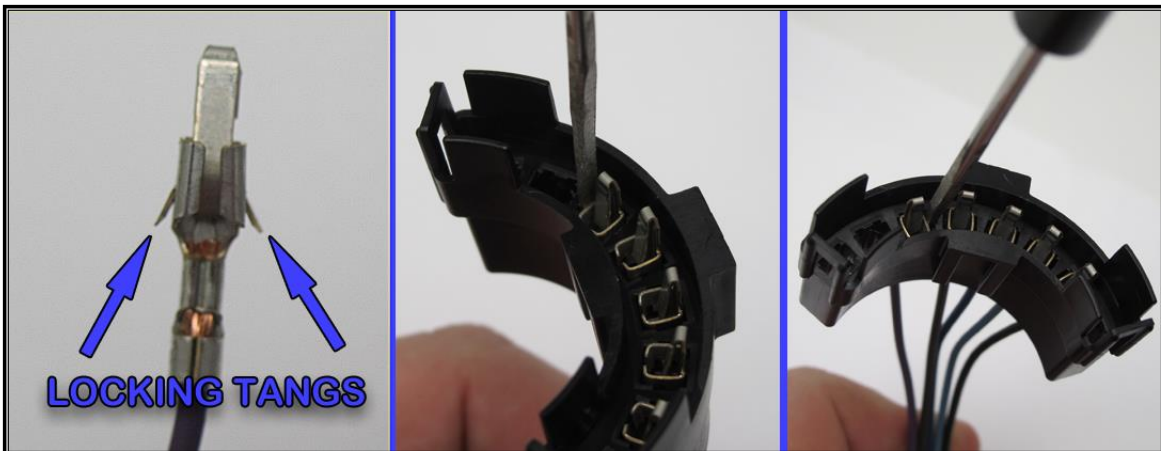

see FRONT LIGHTING SECTION SCHEMATIC

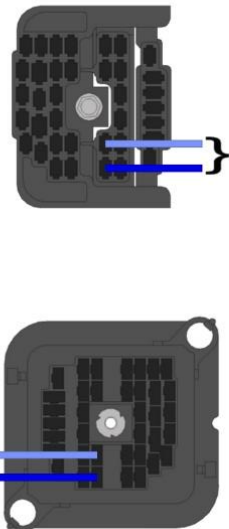

see INSTRUMENT PANEL SCHEMATIC

TURN SIGNAL SWITCH & BRAKE SWITCH SCHEMATIC

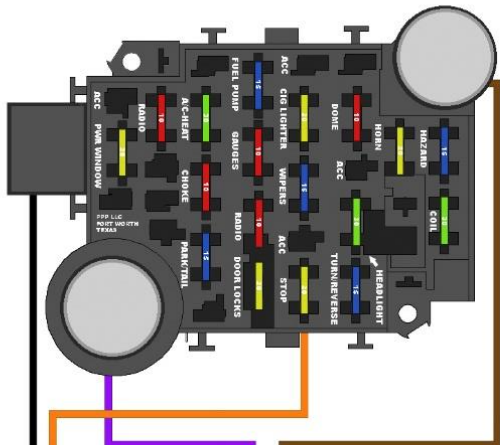

10418

● = FACTORY SPLICE

see TAIL SECTION SCHEMATIC

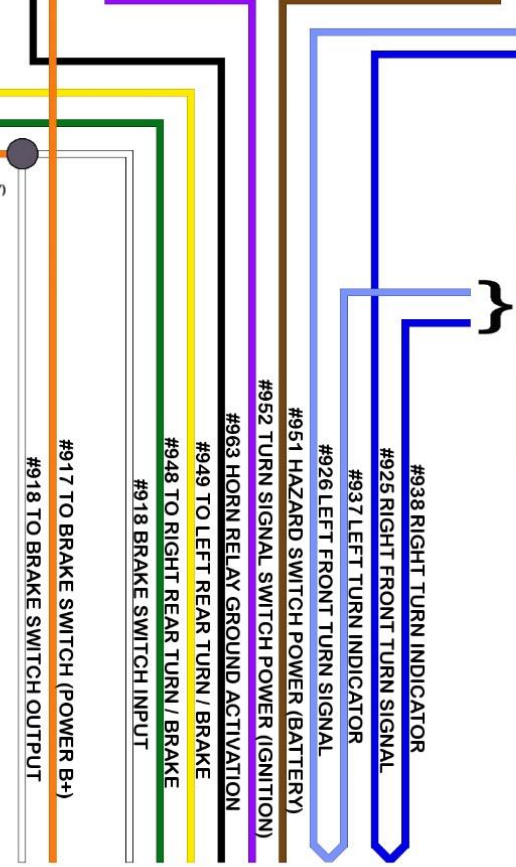
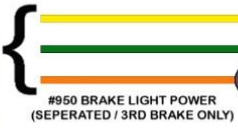

TURN SIGNAL SWITCH

BRAKE SWITCH

10414

see FRONT LIGHTING SECTION SCHEMATIC

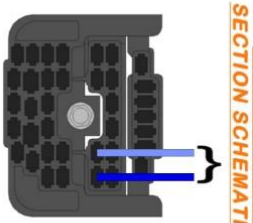

#937 LEFT TURN INDICATOR

#938 RIGHT TURN INDICATOR

see INSTRUMENT PANEL SCHEMATIC

#925 RIGHT FRONT TURN SIGNAL

#926 LEFT FRONT TURN SIGNAL

TURN SIGNAL SWITCH

IGNITION SWITCH

The most important connection of a wiring harness, the ignition switch, controls power to the switched ignition fuses in the fuse block as well as sending power to the starter solenoid to crank the engine.

The ignition switch connection consists of 2 sets of wires with section labels reading "IGNITION SWITCH." All wires going to the ignition switch can be seen in the [Ignition Switch Schematics](#) on the following pages. These wires are:

RED: (2) 12-gauge wires, printed **[IGNITION SWITCH] #934 IGNITION SWITCH POWER (BAT)**, these wires come from a buss bar on the fuse block and feed battery power to the ignition switch. These wires always have power. Harness **10414** will only have one of these wires

ORANGE: 12-gauge wire, printed **[IGNITION SWITCH] #933 IGN POWER TO FUSE BLOCK**, this wire provides the switched power source to the fuse block. This wire powers all the switched power circuits to the harness except for the RADIO fuse. This wire only has power when the ignition switch is in the ON/RUN position.

PINK: 14-gauge wire, printed **[IGNITION SWITCH] #931 IGN POWER TO "COIL" FUSE**, this wire provides power from the ignition switch to the 30-amp COIL fuse on the fuse block. This wire has power when the ignition switch is in the ON/RUN position as well as the START position.

PURPLE: 12-gauge wire, printed **[IGNITION SWITCH] #919 STARTER SOLENOID (START)**, this wire sends power to the starter solenoid and only has power when the ignition switch is in the START position.

BROWN: 12-gauge wire, printed **[IGNITION SWITCH] #932 ACCESSORY POWER**, this wire carries power to the 10-amp RADIO fuse on the fuse block. This **BROWN #932** wire has power when the ignition is in the ACCESSORY position and when in the ON/RUN position.

Since there are so many different types of ignition switches, chose from one of the following that best fits your application:

GM COLUMN MOUNTED (PRE-TERMINATED ON 10413)

Many of the popular retrofitted GM columns people use in their vehicles have the ignition key on the column. The diagram and instructions below demonstrate how to properly connect to this type of ignition switch

- Locate the ignition switch on the top of the steering column, seen in the photos below, and route the "IGNITION SWITCH" wires to the switch.
- **The connectors must be installed in a specific order;** the clear connector needs to be attached first, and then the black. Part of the black connector will overlap the clear connector.

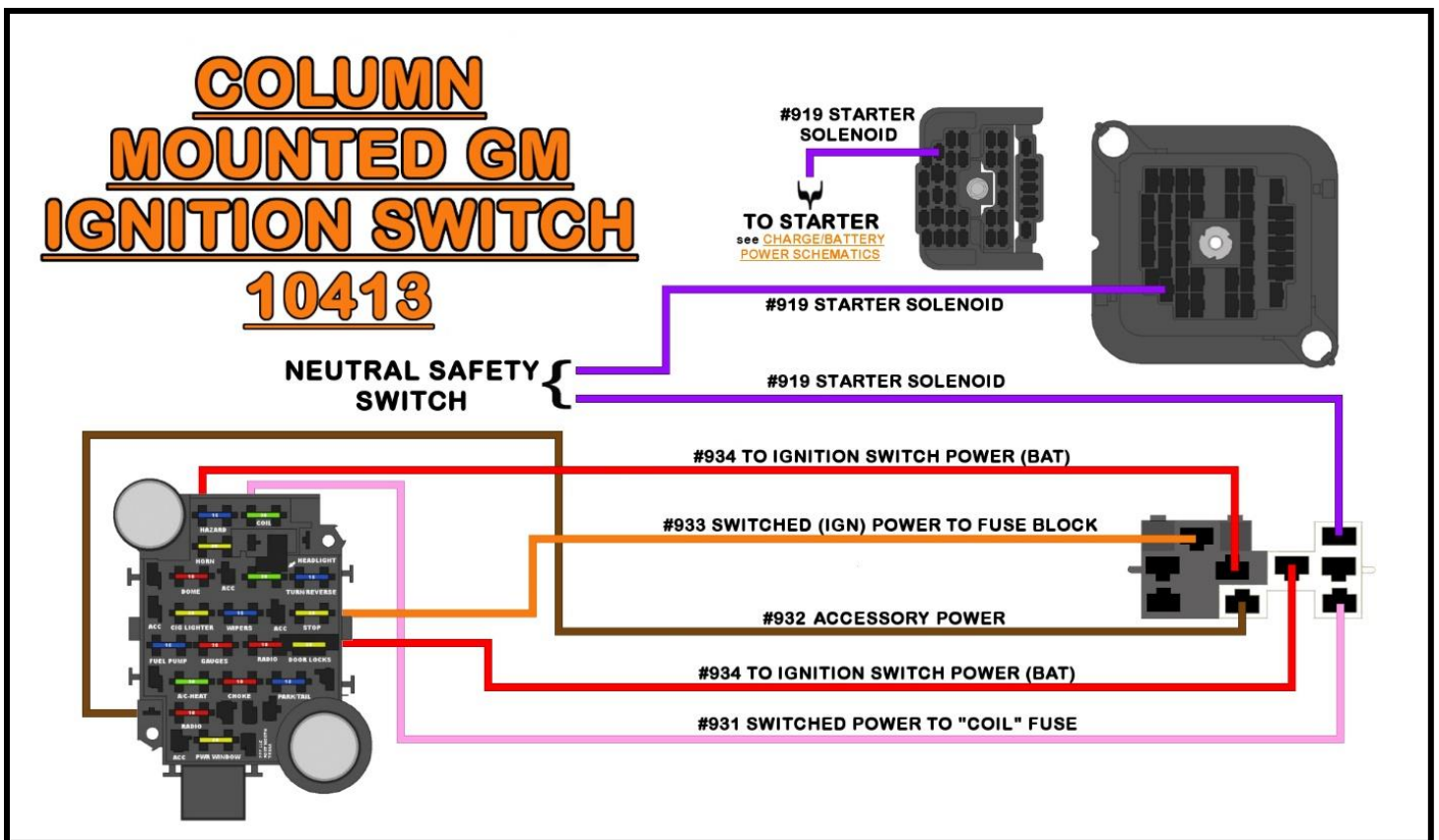
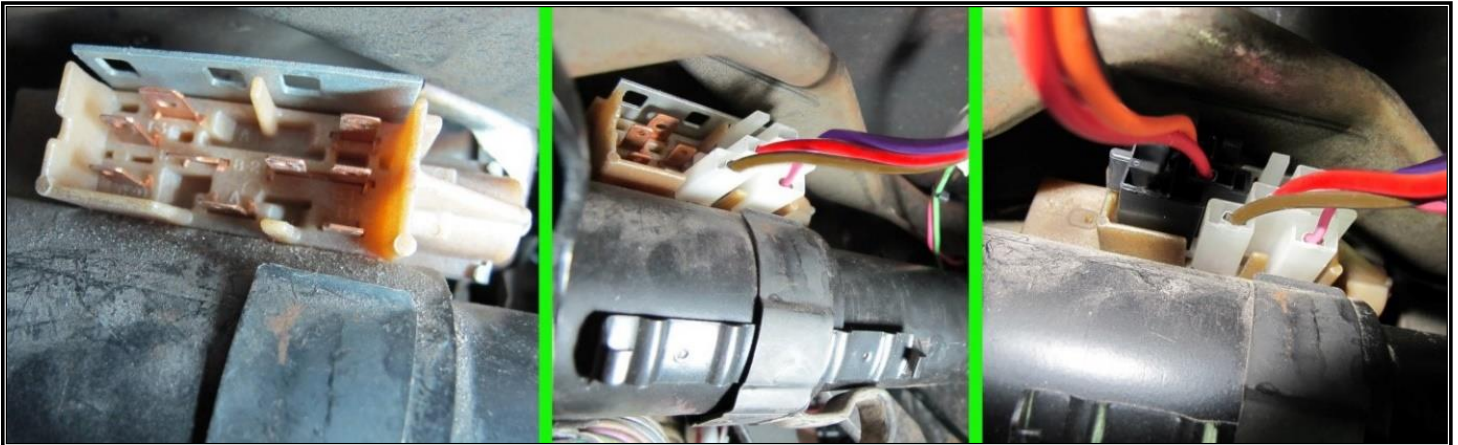

GM DASH MOUNTED (10414)

Your vehicle may have one of the many different dash-mounted ignition switches. Some have functions printed next to each pin on the switch; this allows for identification as to where each wire connects. Others will need a factory schematic to identify the functions of their switch. Below, there are diagrams showing the proper connection of a few of these popular switches.

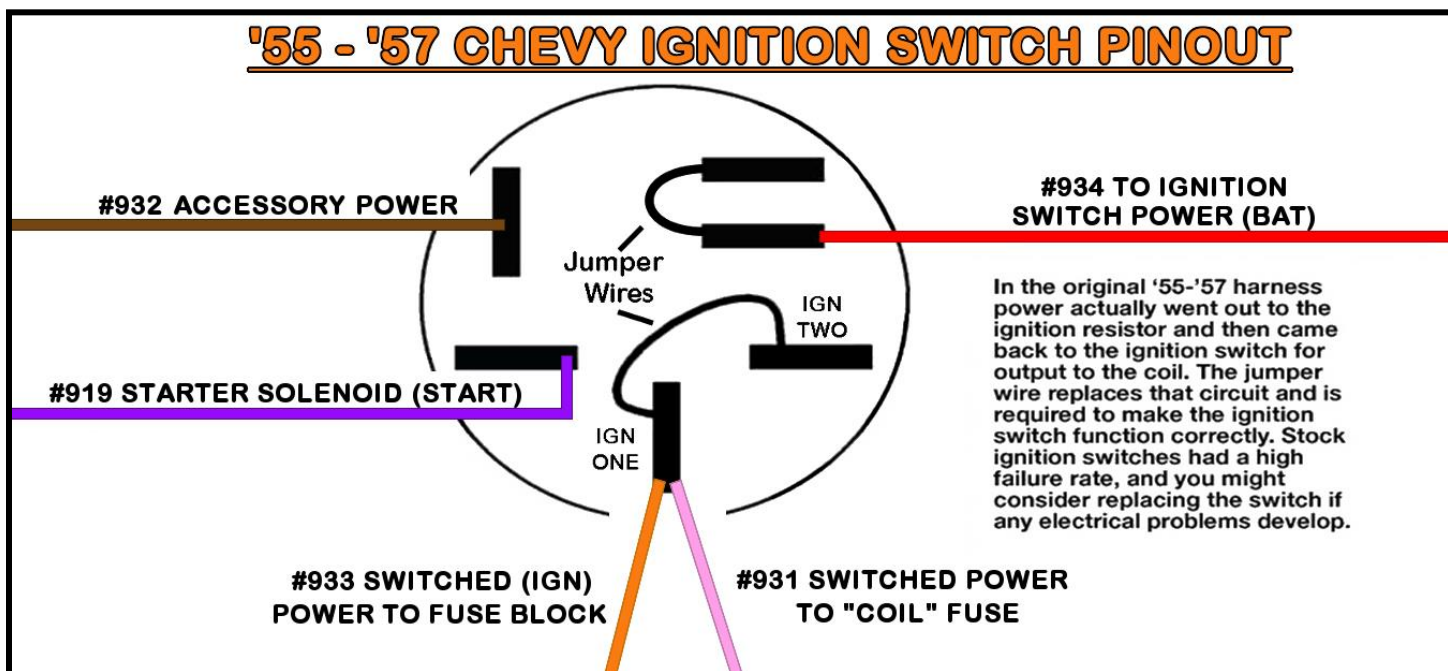
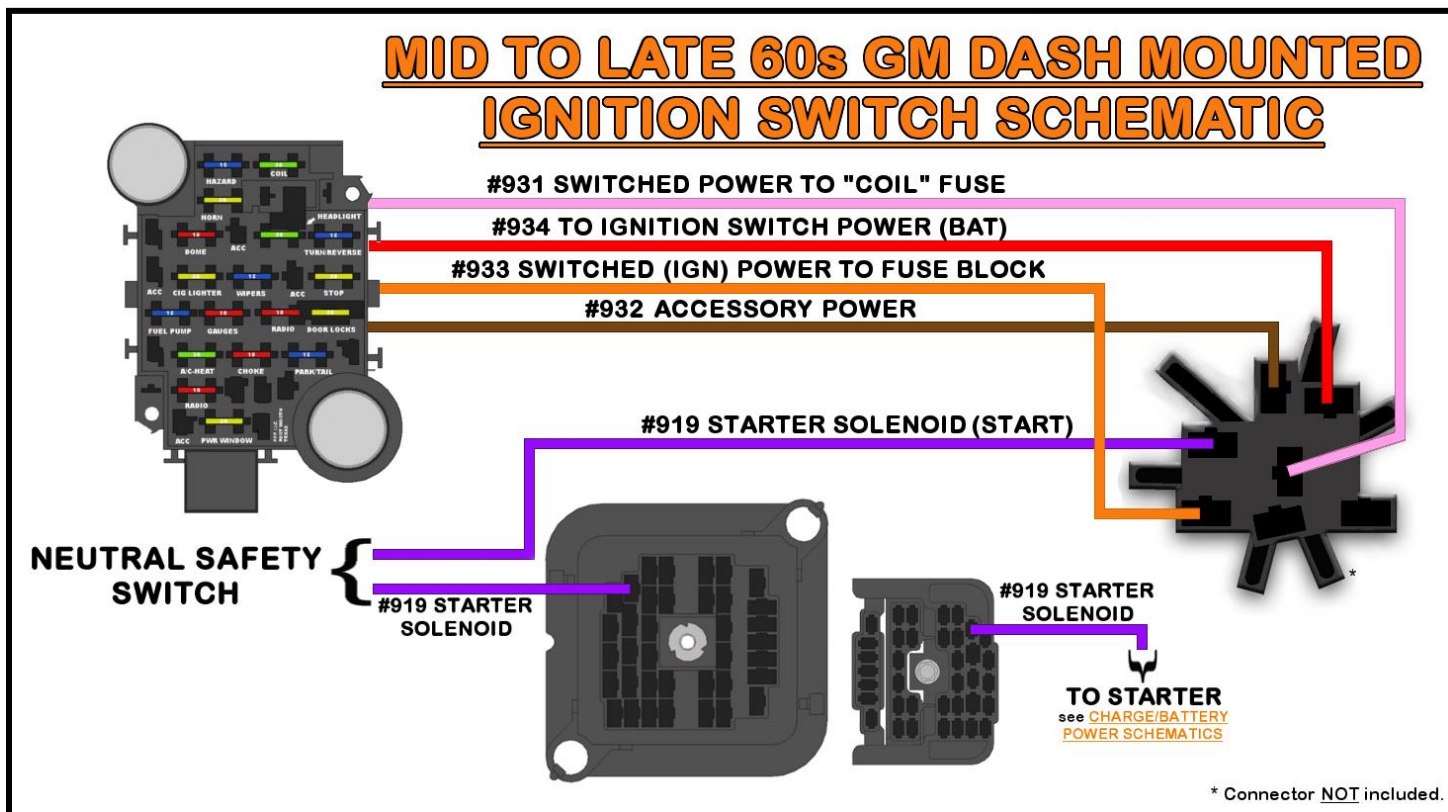

Painless Universal Ignition Switch - #80153

Painless offers a universal, dash mount ignition switch. This switch comes with the trim ring, which screws onto the switch to hold the switch in place, as well as 2 keys. The switch can be found as [part #80153](#) or in switch kit [#80121](#).

- Use insulated ring terminals, found in the parts kit, to make these connections.

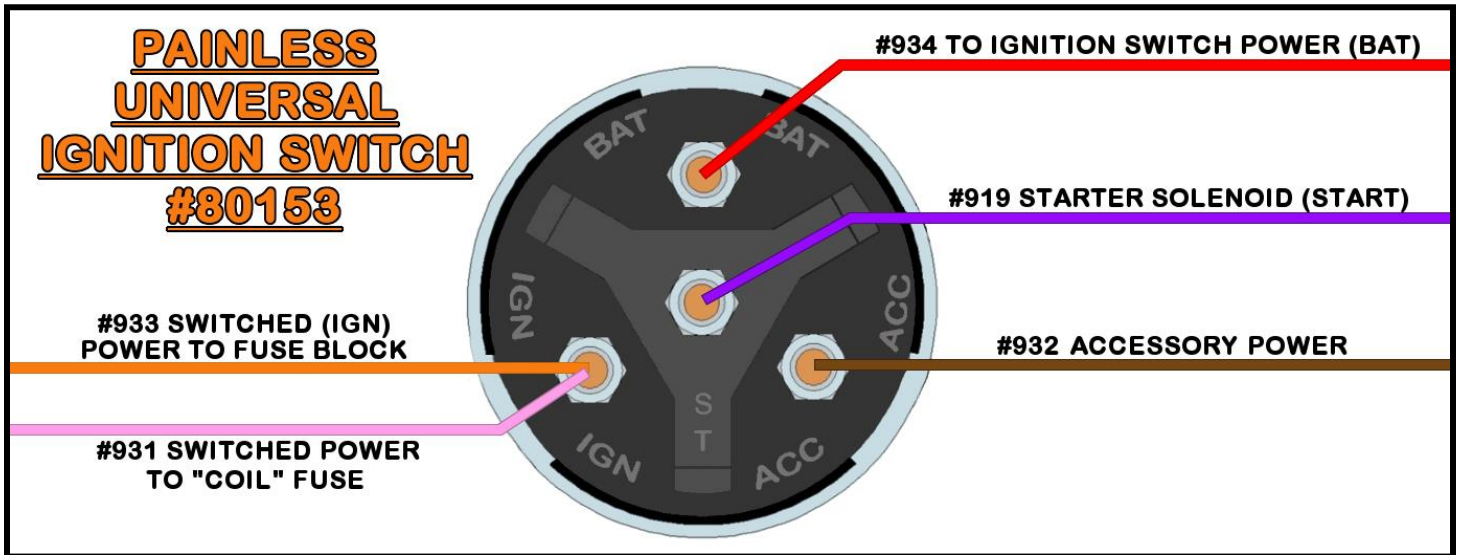

NOTES:

EMERGENCY BRAKE SWITCH

This connection is for the emergency brake switch. This switch activates the brake indicator light on the dash and is tied to the brake warning switch on the master cylinder.

For those that are using aftermarket gauges and/or do not have a brake indicator light, this wire will have no function and can be removed from the harness.

This connection will be one wire; this wire is:

TAN/WHITE: 16-gauge wire, printed **#962 EMERGENCY BRAKE SWITCH**, this wire sends a ground source to the brake warning light in the dash, causing it to turn on when the emergency brake pedal is down. This wire can be seen in the [Engine Schematic](#) on [page 41](#) and the [Instrument Panel Schematic](#) on [page 90](#).

- Route the **TAN/WHITE** **#962** wire to the emergency brake switch and connect using the appropriate connector from the parts kit (typically a bullet or spade terminal).
- You can also cut the molded connector from your factory harness and splice it to the wire of the Painless kit; splices and heat-shrink have been provided

To facilitate making this connection, remove the switch from the emergency brake; there is a single bolt or screw found on the top. Removing the switch will also allow you to clean the mounting point on the emergency brake lever body, as well as the contact points of the switch. Cleaning can be done by using a rough sandpaper or wire wheel on a drill. Doing so will help provide a clean ground source to the brake warning light and may save you some troubleshooting when testing the system upon installation completion.

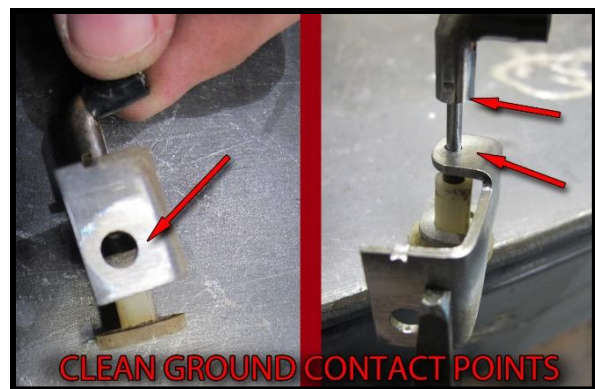
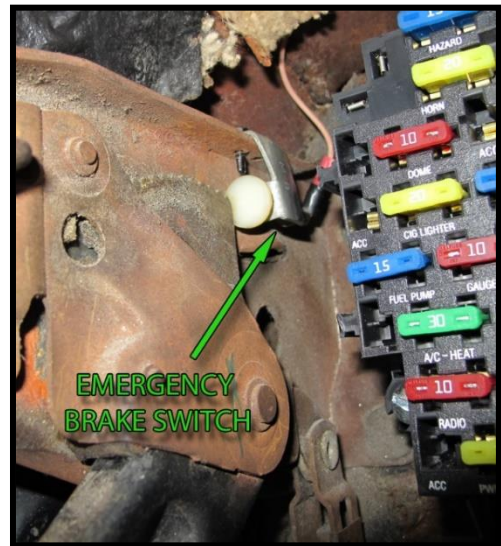

REVERSE SWITCH

The reverse switch connection provides the backup lights the power they need to illuminate. This switch is a 2-pin, normally open switch that has power coming into one side and out the other to the backup lights. When the shifter is put into the reverse position, contact is made between these 2 pins, closing the switch. This allows power to flow from one pin to another, thus transferring power through the switch out to the backup lamps. The 2 wires provided for this option are:

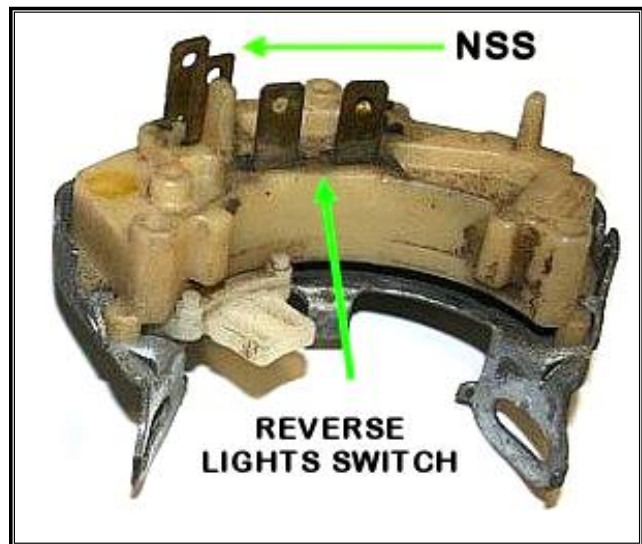

PINK: 18-gauge wire, printed **[REVERSE SWITCH] #958 REVERSE SWITCH**

POWER (IGN), this wire comes from the 15-amp TURN/REV fuse on the fuse block. This wire is a switched ignition power wire meaning it will only have power when the ignition switch is in the ACCESSORY and ON/RUN positions.

If you do not have back up lights, **#958** can be used to power an accessory requiring a switched 12v power source.

LT. GREEN: 18-gauge wire, printed **[REVERSE SWITCH] #956 OUTPUT TO REVERSE LIGHTS**, this wire provides power from the reverse switch to the backup lights in the **Tail Section** of the Painless harness.

- Locate the reverse switch; the location varies depending on your vehicle.

Many of those using a factory GM column can find it at the base of the steering column as seen on the next page.

This same switch can be found at the base of factory console shifters.

- Route the wires to the reverse switch, cut to length, and strip $\frac{1}{4}$ " of insulation.
- A connector and terminals are provided for those with the factory reverse switch seen above. It does not matter which tab each wire connects to.

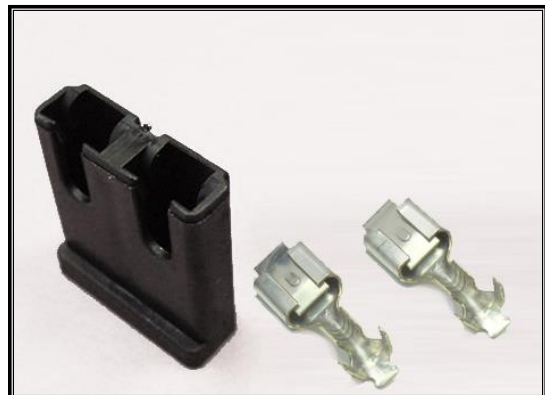

- If you are using an aftermarket floor-mounted shifter, the reverse switch may be found on the base of the shifter. There may also be a neutral safety switch found on the shifter as well. When testing the system, if you notice the reverse lights on when the transmission is in park or neutral, you have the reverse switch wires connected to the neutral safety switch.

Small insulated terminals have been provided in the parts kit to accommodate aftermarket shifter switches.

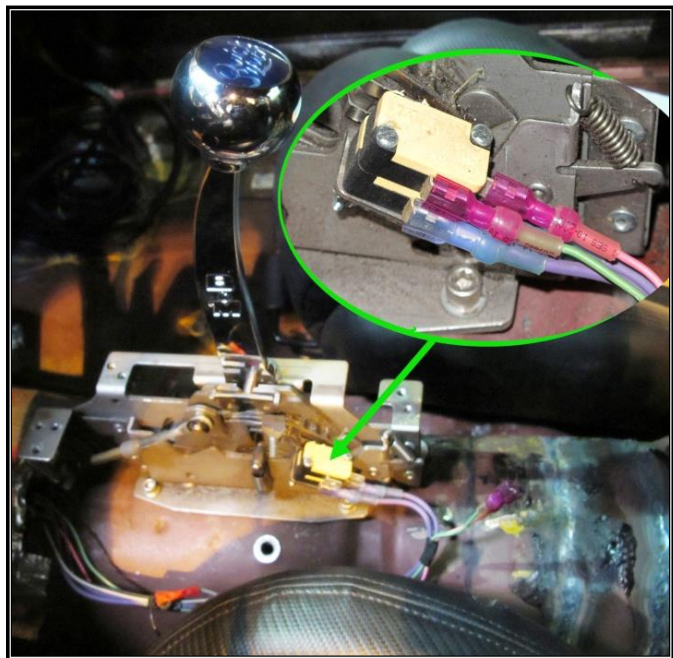

- If you use a transmission mounted reverse switch, the **LT. GREEN #956** and **PINK #958** wires should have been routed through the bulkhead as instructed on [page 17](#).
- Painless offers [part #80175](#) for those using GM TH350, TH400, 700-R4, TH200, 200-4R, & 4L60 transmissions. This part can be used as either a reverse switch or a neutral safety switch.

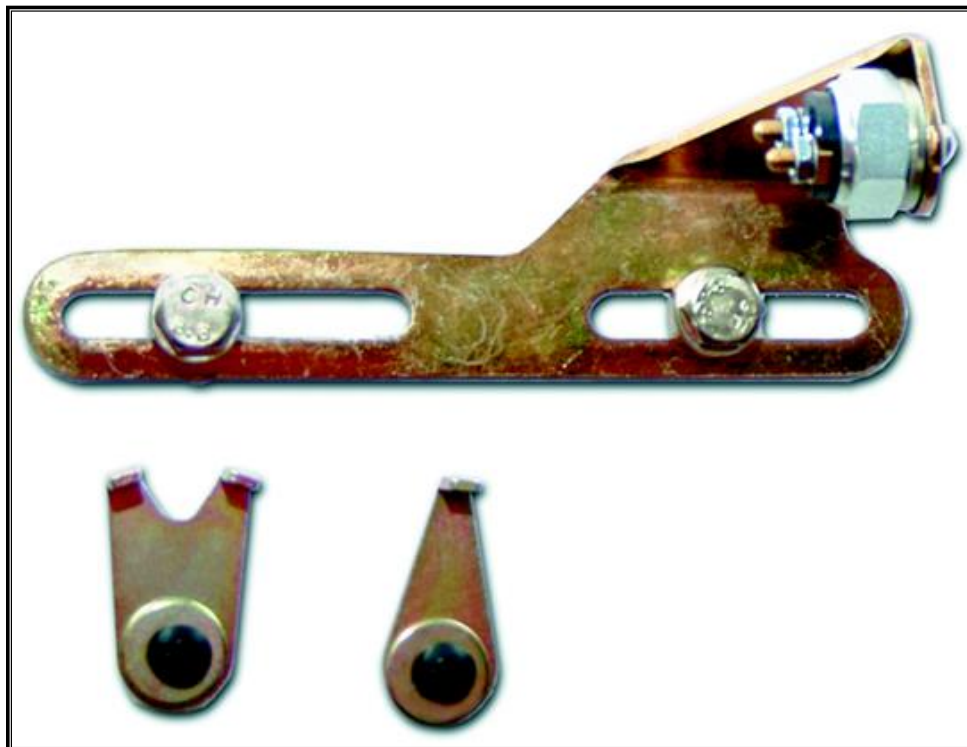

NEUTRAL SAFETY / CLUTCH SWITCH

This switch is a safety device that prevents the vehicle from being started while in gear and causing an unfortunate accident. The purpose of this switch is to only allow the engine to be started when the vehicle is in park or neutral (automatic transmissions) or if the clutch pedal is depressed (manual transmissions). When the transmission is put into park/neutral or the clutch pedal is depressed, contact is made between these 2 pins, closing the switch. This allows power to flow from one pin to another, transferring power through the switch to the starter solenoid.

The neutral safety/clutch switch connection is 2 wires:

PURPLE: 12-gauge wire, printed **[IGNITION SWITCH] #919 STARTER SOLENOID (START) [NSS]**. This wire comes from the ignition switch and only has power when the switch is in the START position. This wire provides power to the neutral safety switch (NSS) from the ignition switch.

PURPLE: 12-gauge wire, printed **[NSS] #919 STARTER SOLENOID (START)**, this wire provides power from the NSS to the starter solenoid “S” terminal. This wire can be seen in the [Charge / Battery Power Schematic](#) on [page 64](#) and the various ignition switch schematics found on [pages 83 – 85](#).

- If you have an automatic transmission with a column shift, the NSS is usually located at the base of the steering column, as seen in the photo with the reverse switch on [page 87](#). This same switch can be found at the base of factory console shifters.

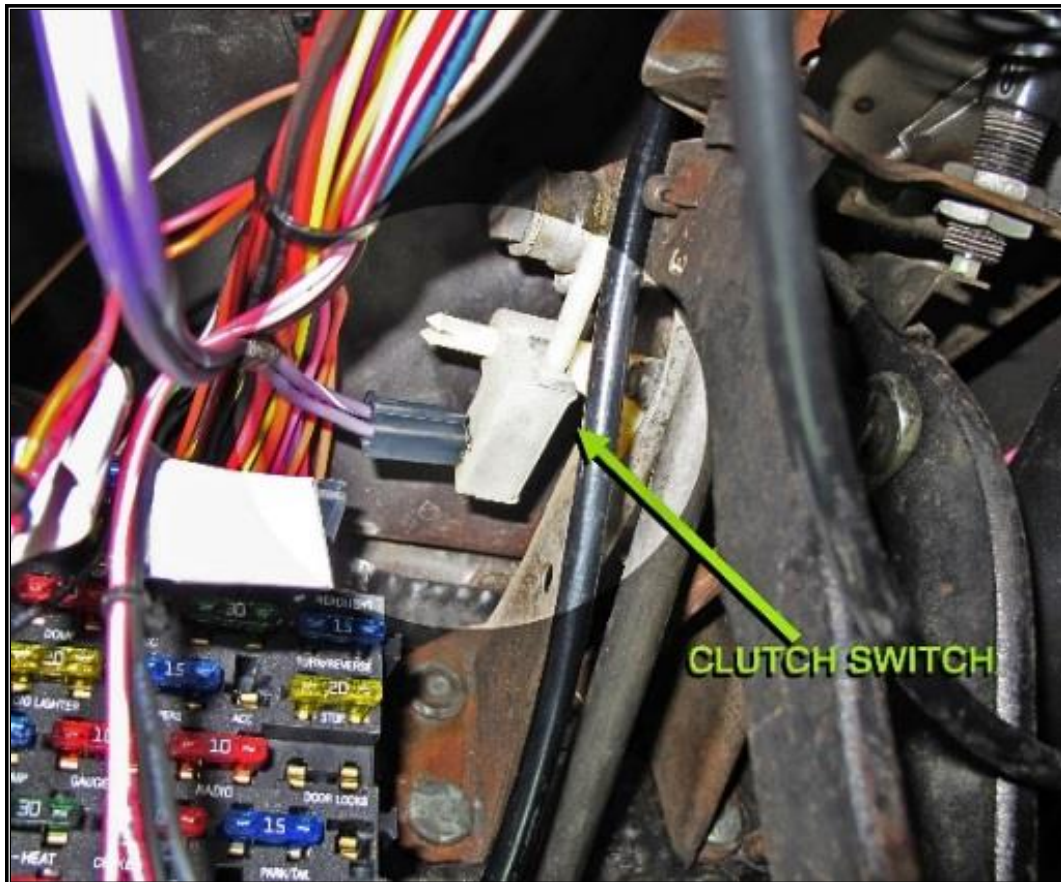

If you are using an aftermarket floor shifter:

- If you have a manual, the clutch switch is located at the top of the clutch pedal, much like the brake switch on the brake pedal.
- Route the wires to the NSS, cut to length, and strip $\frac{1}{4}$ " of insulation. Also, strip $\frac{1}{4}$ " of insulation from the cutoff piece of **PURPLE #919** wire as it will connect to the switch as well.

A connector, seen in the photo, and terminals have been provided for those with the factory reverse switch seen above. It does not matter which tab each wire connects to. Once connected to the switch, route the cutoff portion of the **PURPLE #919** wire through the bulkhead to the "S" terminal on the Starter and connect as mentioned on the previous.

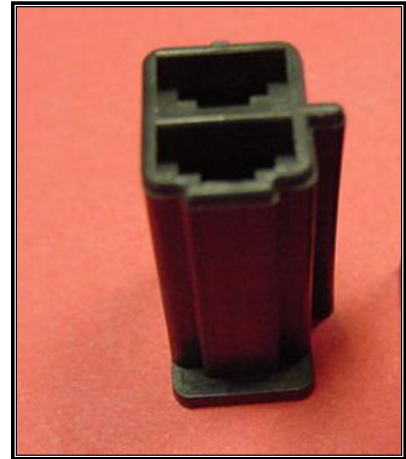

- **If you do not have a neutral safety/clutch switch and do not plan on getting one, connect these 2 PURPLE #919 wires.**

Painless does not recommend operating your vehicle without a neutral safety/clutch switch.

NOTES:

INSTRUMENT PANEL

The instrument panel connections of the Painless harness vary according to the gauge cluster or aftermarket gauges you are using. The wires for this connection are grouped together. These wires are:

GREY: 18-gauge wire, printed **[INSTRUMENT PANEL SECTION] #930 INSTRUMENT PANEL LIGHTING**, this wire provides a power source for gauge backlighting. The **GREY #930** is tied to the **GREEN #930** wire coming from the headlight switch and the other 2 **GREY #930** wires going to the panel & radio backlight/dim. This wire has power anytime the headlight switch is in the Park/Taillights ON or Headlights ON position. This wire can also be seen in the [Headlight & Dimmer Switch Schematic](#) on [page 72](#).

TAN: 18-gauge wire, printed **[TAIL SECTION] #939 FUEL LEVEL SIGNAL [INSTRUMENT PANEL SECTION]**, this wire is a ground signal from the fuel level sending unit in the fuel tank. The resistance to ground will vary on this wire according to the amount of fuel in the tank. This wire can also be seen in the [Tail Section Schematics](#) on [pages 117 & 118](#).

TAN/WHITE: 18-gauge wire, printed **[INSTRUMENT PANEL SECTION] #962 TO BRAKE WARN INDICATOR**, this wire provides the ground signal to the brake warning light on the dash. This wire is tied to the brake warning switch on the master cylinder and the emergency brake switch. These wires can be seen in the [Engine Schematic](#) on [page 41](#) and the [Instrument Panel Schematic](#) on [page 100](#).

PINK: 18-gauge wire, printed **[INSTRUMENT PANEL SECTION] #935 GAUGE POWER (IGN)**, this wire provides a switched ignition power source to the cluster. This wire comes from the 10-amp GAUGES fuse on the fuse block. This wire has power anytime the key is in the ON/RUN position.

GREEN: 18-gauge wire, printed **[INSTRUMENT PANEL SECTION] #921 COOLANT TEMP SIGNAL**, this wire is a ground signal from the engine coolant temperature sending unit. The sending unit will create resistance to ground according to engine temperature. This resistance is transferred through this wire to the gauge.

BROWN: 18-gauge wire, printed **[INSTRUMENT PANEL SECTION] #923 TACHOMETER SIGNAL**, this wire is a ground signal from the negative side of the ignition coil. This wire can also be seen in the coil connection diagrams on [pages 49 – 50](#).

LT. BLUE/BLACK: 18-gauge wire, printed **[INSTRUMENT PANEL SECTION] #922 OIL PRESSURE SIGNAL**, this wire is a ground signal from the oil pressure sending unit. The sending unit will create resistance to ground according to oil pressure. This resistance is transferred through this wire to the gauge.

LT. GREEN: 18-gauge wire, printed **[INSTRUMENT PANEL SECTION] #936 HIGH BEAM INDICATOR**, this wire provides power to the high beam indicator when the headlight switch is in the “ON” position and the dimmer switch is in the “HIGH” position.

LT. BLUE: 18-gauge wire, printed **[INSTRUMENT PANEL SECTION] #937 LEFT TURN INDICATOR**, this wire provides power to the left turn indicator when the turn signal switch is in the left turn position.

BLUE: 18-gauge wire, printed **#938 RIGHT TURN INDICATOR [INSTRUMENT PANEL SECTION]**, this wire provides power to the right turn indicator when the turn signal switch is in the right turn position.

FACTORY PRINTED CIRCUIT GAUGES

A factory schematic or your factory harness is necessary to identify the connector pinout needed for your gauges. This kit provides a factory, 12-pin connector and terminals, shown here, that fit most factory, GM printed circuit gauge clusters. If your cluster requires a bigger or smaller connector, use the new terminals provided and re-use your factory connector.



- Use a factory schematic or your factory harness to fill in the blanks on the image below with the function and/or Painless wire color and circuit number for each connector location.

If you have a charge/alternator light, the **BROWN #914 ALTERNATOR REGULATOR POWER (IGN)** wire that provides ignition power to the alternator needs to be routed to the gauge cluster and cut to length. The cut off portion then needs to be routed from the gauge cluster out to the alternator.

If you have a brake warning light, a wire (not supplied) needs to be run from the gauge cluster to the emergency brake switch and the brake warning switch if equipped. This was most commonly an 18 ga tan wire on factory harnesses.

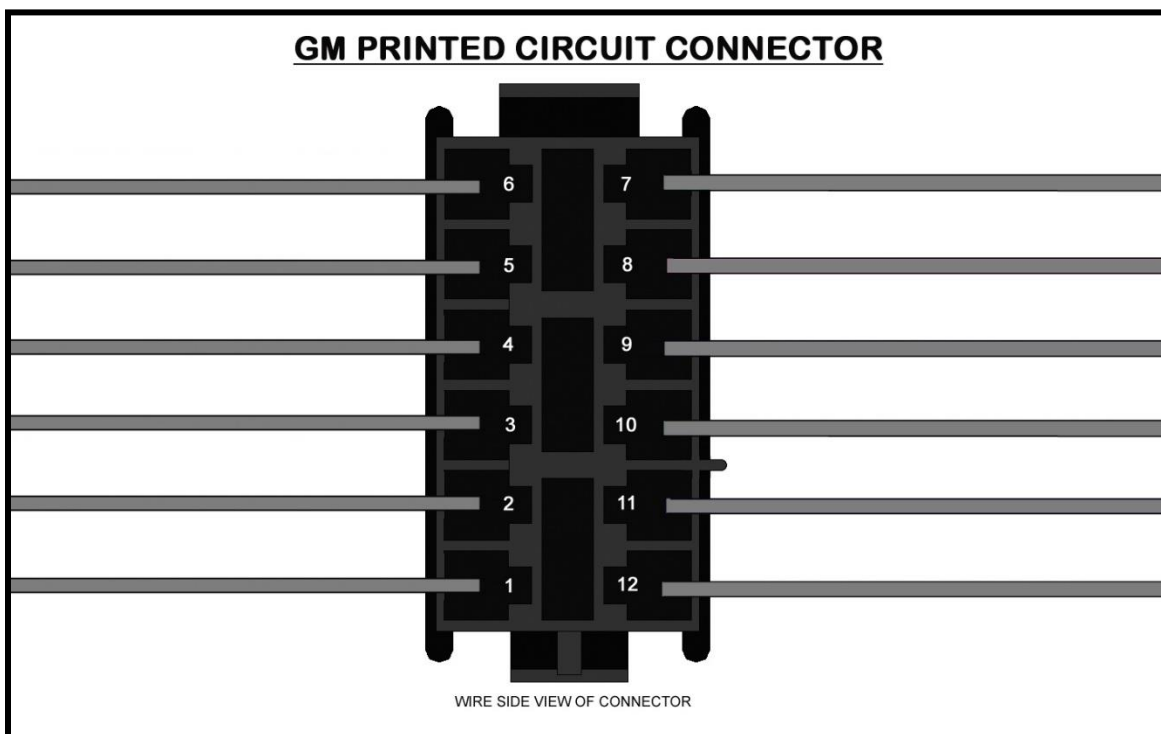

SEPARATE HARNESS – PAINLESS #30301 & 30302

To facilitate wiring individual aftermarket gauges Painless offers, and recommends, the use of **Painless part #30301** (#30302 if using an electric speedometer). This is a universal gauge cluster harness that has all the splicing and termination pre-installed for these types of applications. This harness also offers you the benefit of having an inline connector instead of hardwiring the chassis harness directly to the gauges.

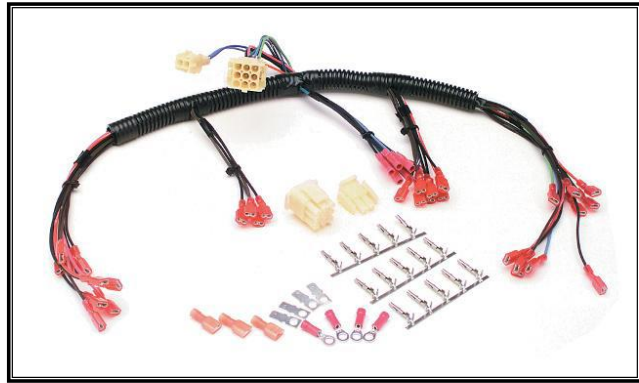

- Using the terminals and connector found in the **30301** or **30302** kits, install the wires of the Painless chassis harness according to the diagram below. Use the numbers on the connectors as well as the circled reference points in the diagram for proper cavity location. A gauge light ground will not be used.

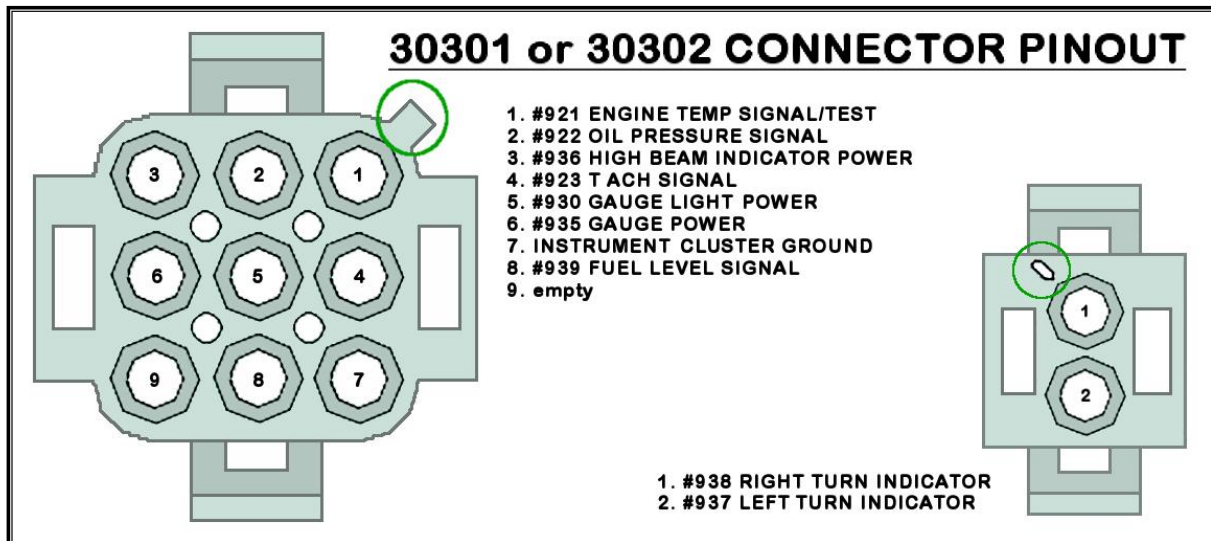

HARDWIRING:

For those who choose to wire aftermarket gauges with just the wires found in the Painless chassis harness, and not purchase an additional gauge harness, the following steps will walk you through the process of distributing power and ground as well as connecting the sender wires. The following diagrams only show temp, oil pressure, volt, and fuel level gauges. Power, ground, and sender wires connect in the same manner to speedometers and tachometers.

Power to the gauges comes from the **PINK #935** wire, and it needs to be connected to the "I" or "12V" post on each gauge. The power wire can be connected in one of two ways:

#1) Splicing - This is when you connect multiple wires to a single wire to distribute power/ground to multiple components. In this case, splices on the **PINK #935** wire are running wires to several gauges to provide power to each gauge.

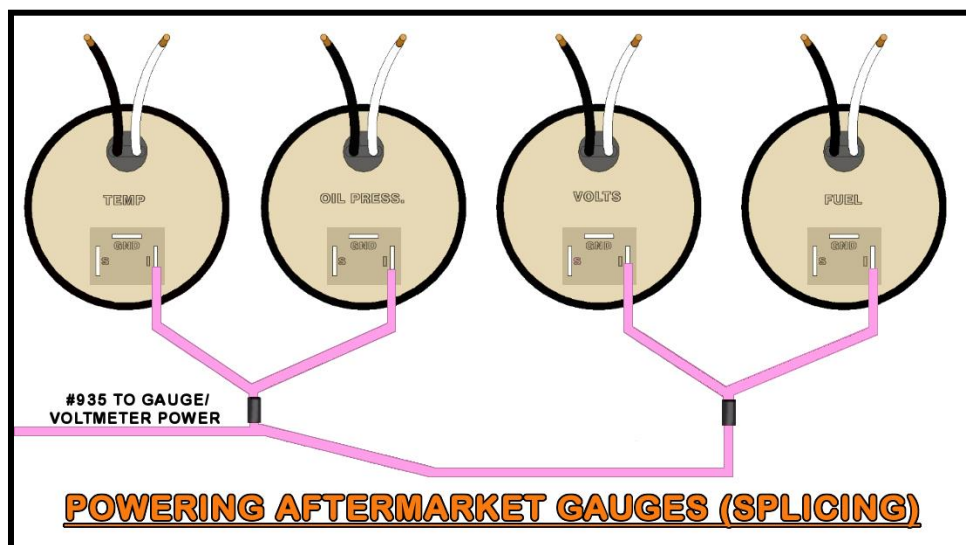

#2) Chaining or Jumpering - Run the **PINK #935** wire to a power post. **Before terminating the wire** with the proper terminal, insert another wire into the terminal and crimp. You now have 2 wires in 1 terminal. This additional wire then routes to the next gauge's power post. Before terminating that wire with the proper terminal, insert another wire into the terminal; and so on.

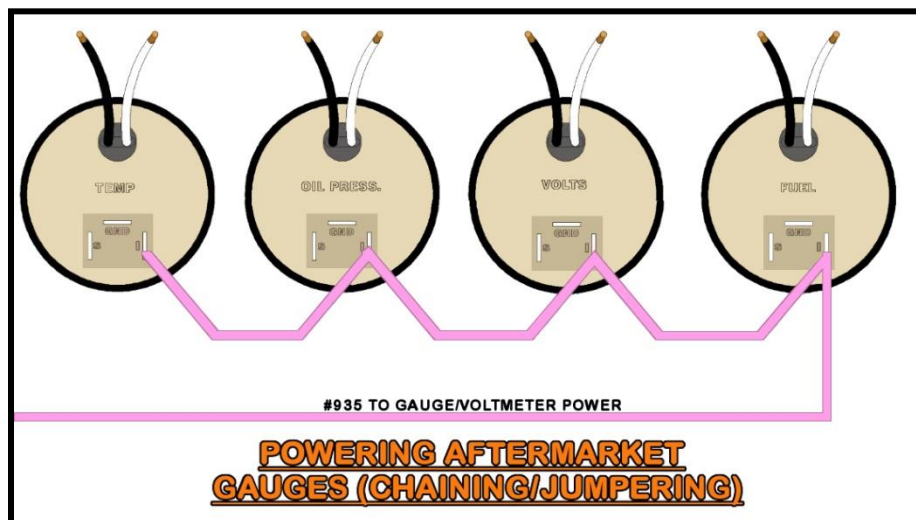

Grounds need to be supplied to the gauge lights and any ground tab on the gauges. The installer needs to run a ground circuit for gauge connections. To make these ground connections you can splice from the installer provided ground wires to all the gauges or chain/jumper it all together. Both methods can be seen in the following two drawings:

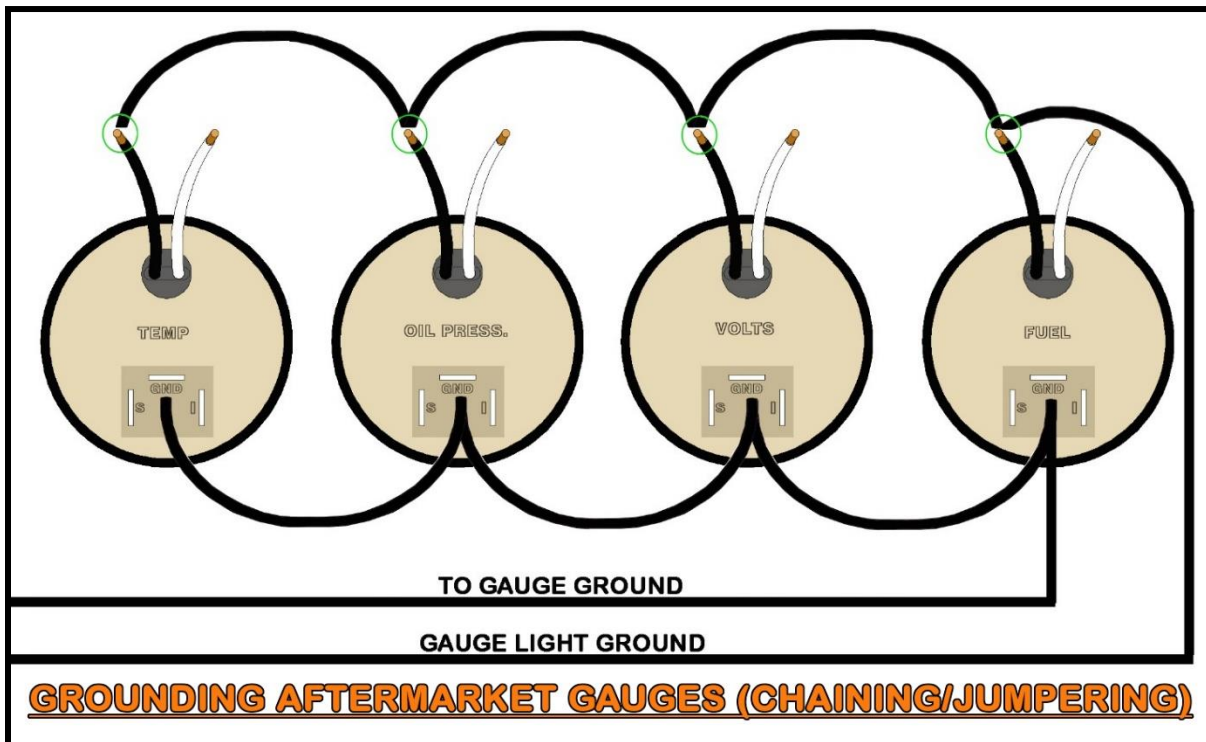
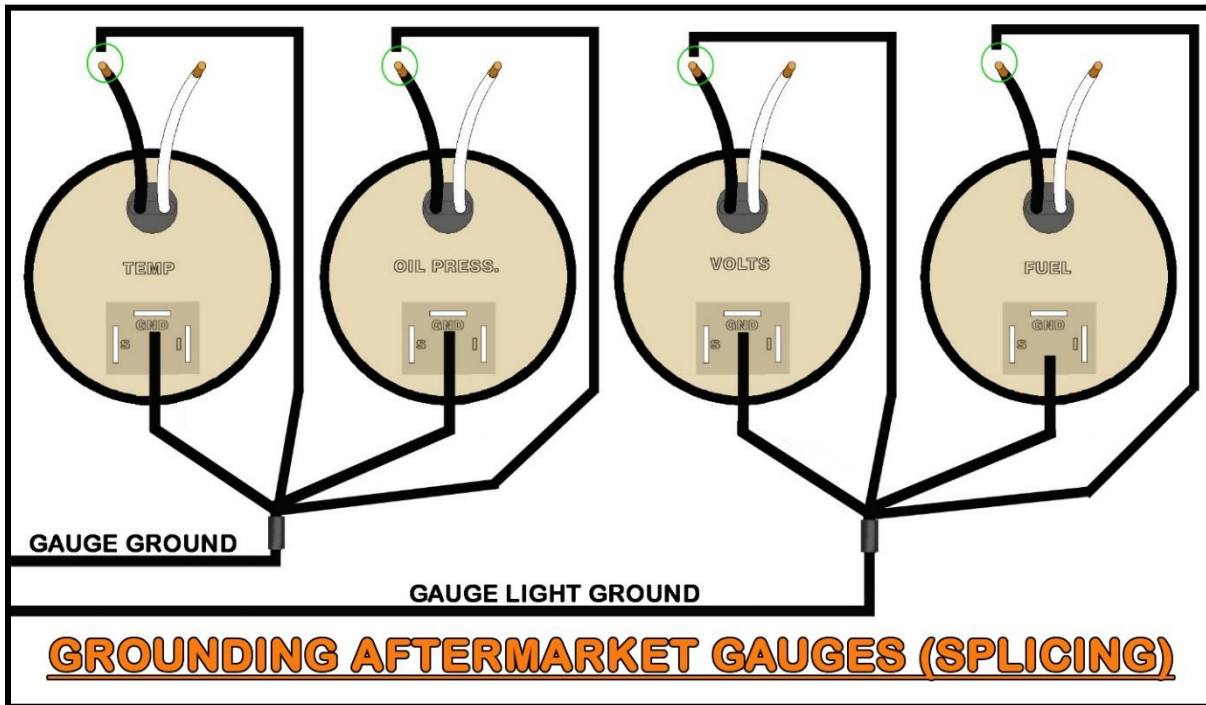

Gauge light power is supported by the **GREY #930** wire. This wire connects to one of the leads for the gauge light or the gauge light tab found on gauges with LED backlighting. To make these connections you can splice from this **GREY #930** wire to all the gauges or chain/jumper it all together.

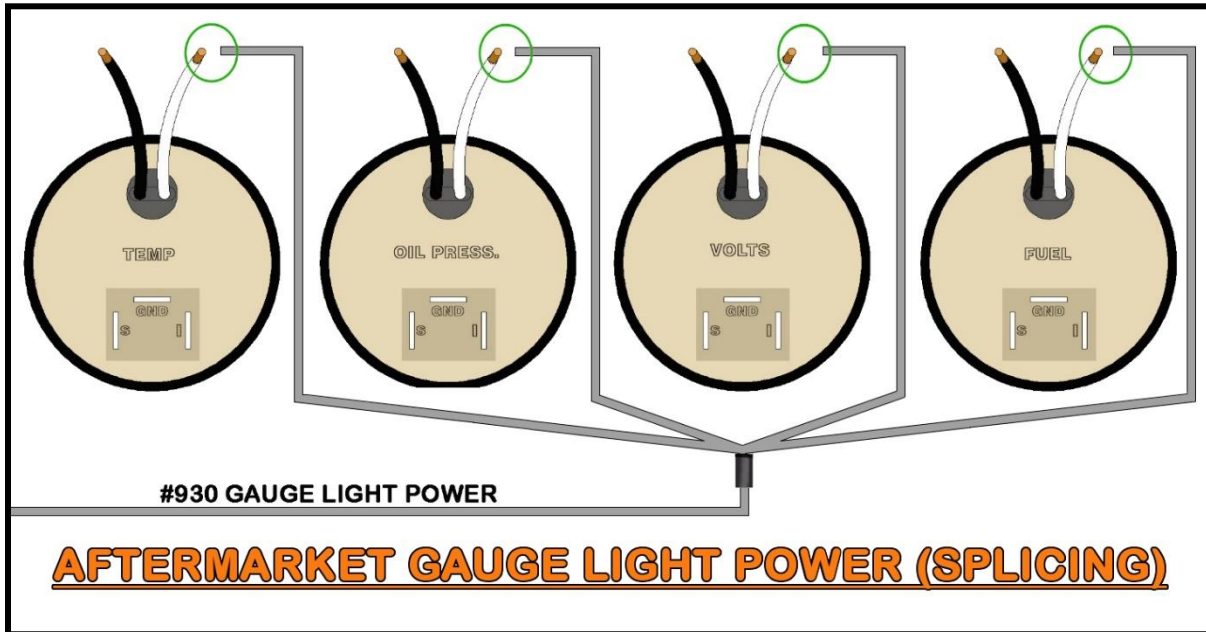

The last connections that need to be made are the sending unit wires or signal wires. These are the wires which come from the temperature sending unit, oil pressure sending unit, and fuel level sending unit. Not shown in the diagram, but also provided in the Painless chassis harness is the **BROWN #923 TACHOMETER SIGNAL** wire.

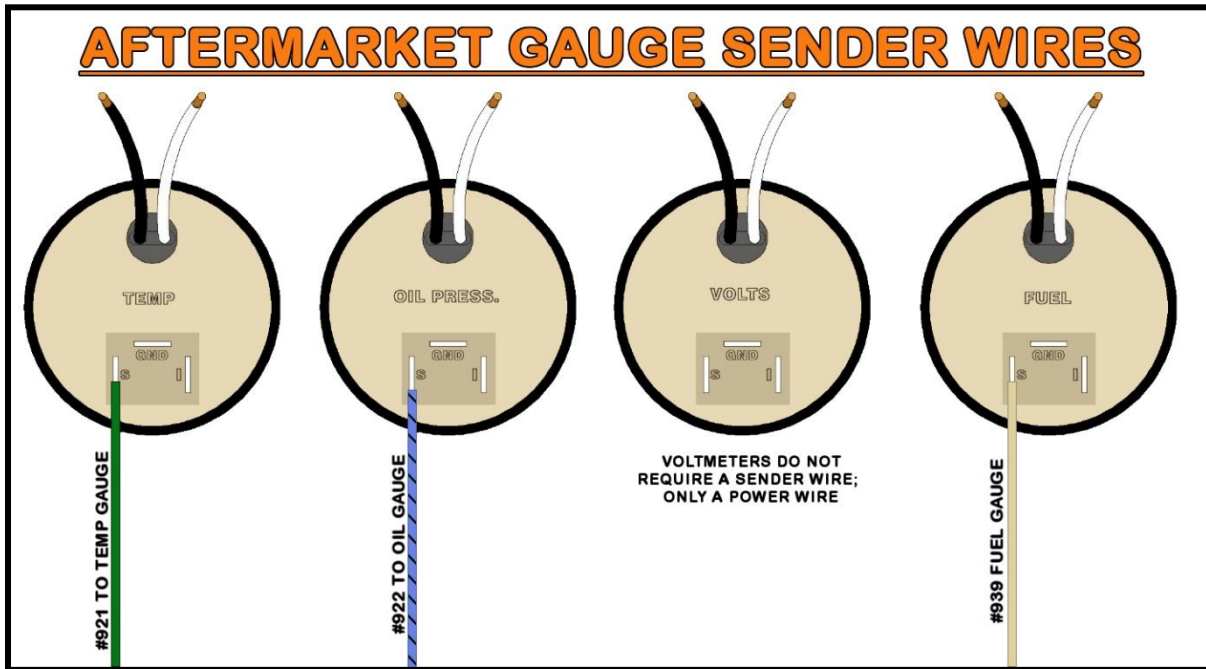

NOTES:

INSTRUMENT PANEL SCHEMATIC

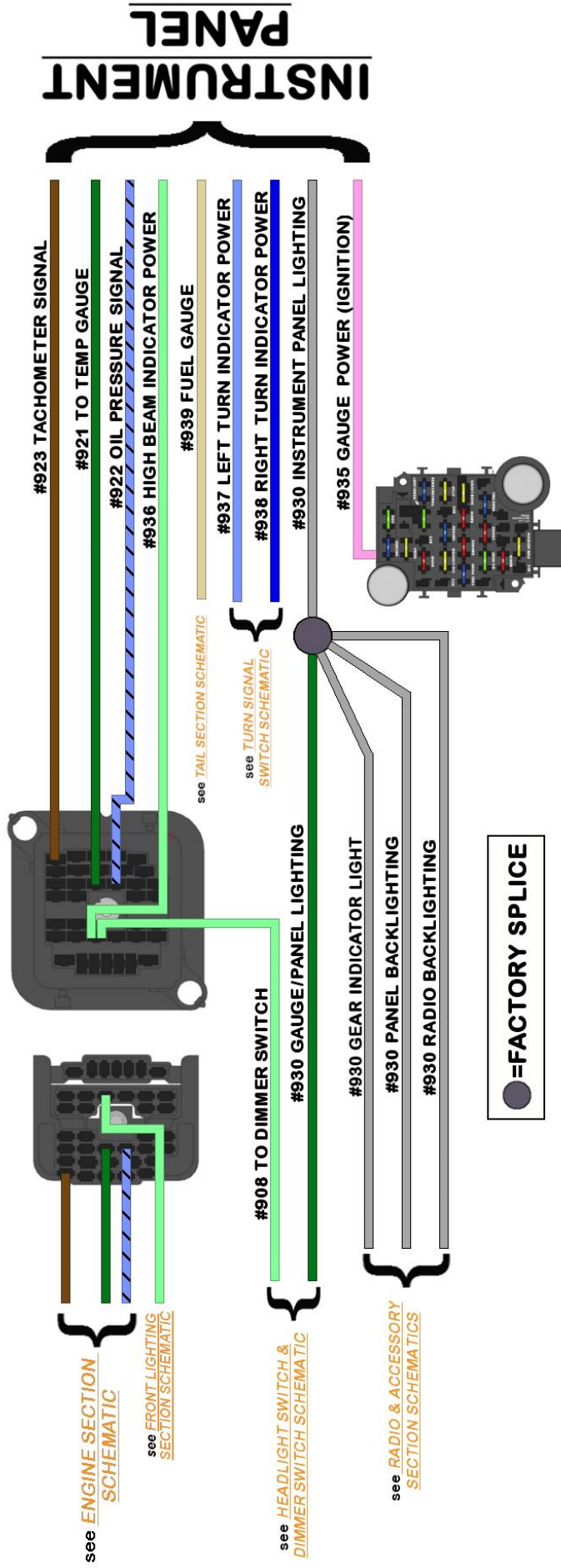

RADIO & ACCESSORIES

This Painless harness includes provisions for several accessory components that may or may not be used on your install. These accessory wires include wiper power, which should have already been connected. Below, you will find information about each of these accessories and the wires provided in this harness to connect them.

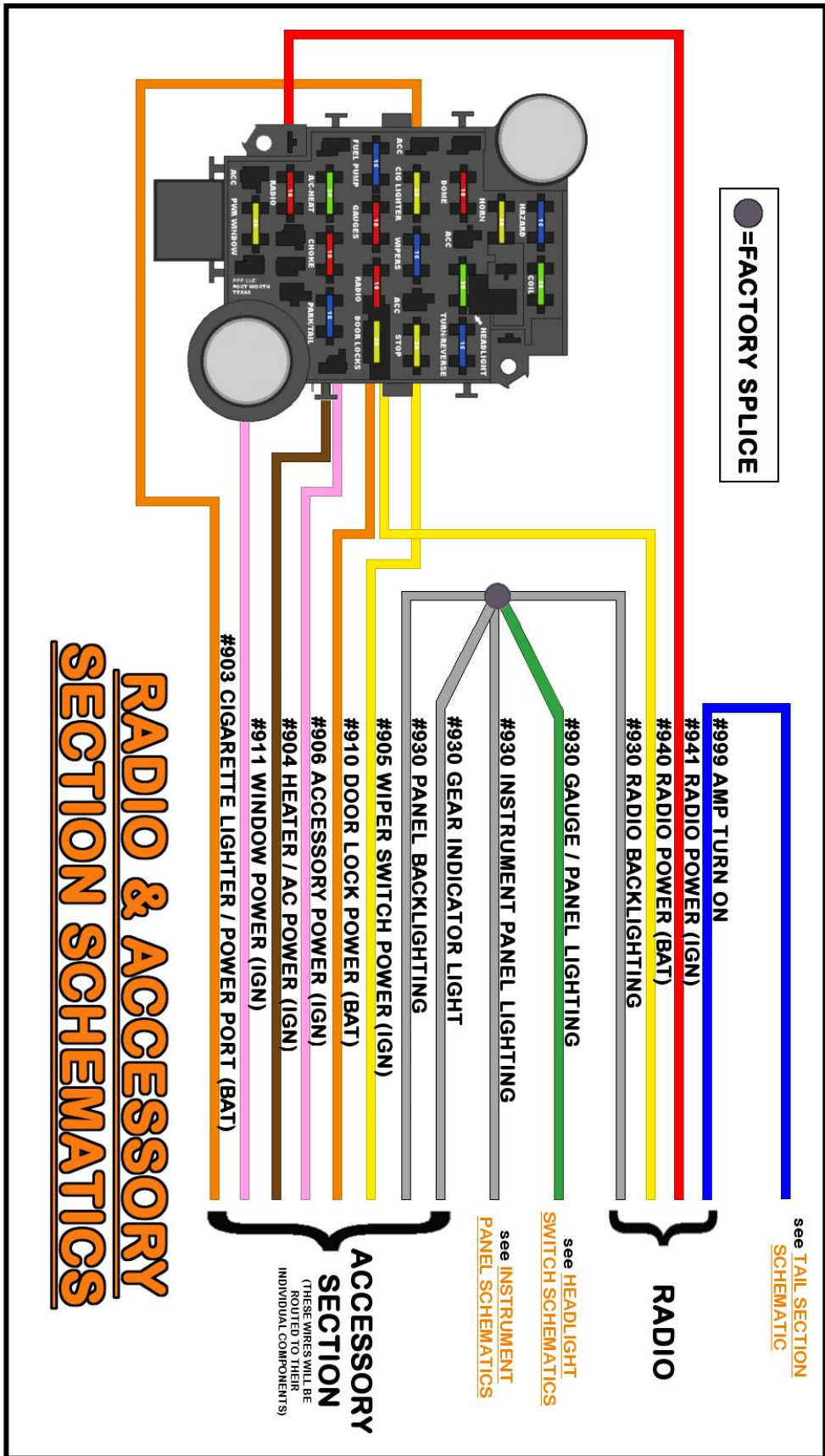

RADIO & ACCESSORY SECTION SCHEMATICS

RADIO

The radio connection on the Painless harness is set up for a universal application. This means the wire colors used by Painless reflect the colors most aftermarket companies use on radios/head units manufactured today. The Painless harness includes 4 wires dedicated to a connection to the radio. These 4 wires are:

YELLOW: 18-gauge wire, printed **[RADIO SECTION] #940 RADIO POWER (BAT)**, this wire provides the radio a battery power source that allows the time and radio presets to remain every time the ignition is turned off. This wire comes from the fuse block and can be seen in the [Radio & Accessory Schematic](#) on [page 99](#).

RED: 18-gauge wire, printed **[RADIO SECTION] #941 RADIO POWER (IGN)**, this wire provides the radio with ignition switched power for operation. This wire has power when the ignition switch is in the ACCESSORY and ON/RUN positions. This wire comes from the 10-amp RADIO fuse of the fuse block and can be seen in the [Radio & Accessory Schematic](#) on [page 99](#).

GREY: 18-gauge wire, printed **[RADIO SECTION] #930 RADIO BACK LIGHTING**, this wire provides a power signal to the radio to dim the backlighting/display during low light conditions. On older radios, this power source illuminates the backlighting. This wire has power anytime the headlight switch is in the Park/Taillights ON or Headlights ON position. This wire/splice can be seen in the [Radio & Accessory Schematic](#) on [page 99](#).

BLUE: 18-gauge wire, printed **[RADIO SECTION] #999 AMP TURN ON [TAIL SECTION]**, this wire provides switched power from the head unit to an amplifier. You will only need this wire if you have an audio amplifier.

- If you use an aftermarket radio, refer to the manufacturer's installation guide for proper connection. Splices and quick-disconnect terminals are provided in the parts kit.
- If your radio/head unit does not have a "Remote Turn On" output, connect the **BLUE #999** wire with the **RED #941** wire to provide switched ignition power to the Amplifier. Be aware that this will provide power to the amplifier any time the ignition key is in the ACCESSORY or ON/RUN position.
- If you are using a factory radio, a factory schematic for the vehicle it came out of is needed to identify the connections to the radio.

Many older, factory radios require one power source. Painless recommends connecting the **RED #941** wire to the radio in these circumstances so that the radio will only operate when the ignition switch is in the ACCESSORY or ON/RUN position. This prevents the radio from draining the battery if it is accidentally left on.

- **You must supply a ground for the radio.**

ACCESSORY SECTION

The Accessory Section of the Painless harness consists of 5 wires for various accessory applications. Locations of all these components vary from vehicle to vehicle, so no specific routing instructions can be given.

YELLOW: 16-gauge wire, printed **[ACC. SECTION] #905 WIPER SWITCH POWER (IGN)**, this wire provides ignition switched power to the wiper motor or switch depending on your set-up.

- This wire should have been rerouted to either the wiper motor or wiper switch on [page 17](#). See Wiper Section of [page 39](#) and the Wiper Switch Section on [page 75](#).

BROWN: 14-gauge wire, printed, **[ACC. SECTION] #904 HEATER/ AC POWER**, this wire comes from the 30-amp A/C-HEAT fuse and provides a switched ignition power source for a factory or aftermarket A/C system.

- Install mating insulated terminals onto the **#904** and to the wire of your aftermarket A/C system harness that requires a fused, switched ignition, 12v source.

Those using factory heater or A/C harness:

As previously mentioned on [page 15](#), this harness does not include any wiring for the factory air conditioning or wiring to the blower motor and blower motor resistor; your original harness or a reproduction of the original harness must be used. The Painless harness plugs directly into a factory/reproduction harness without any modifications.

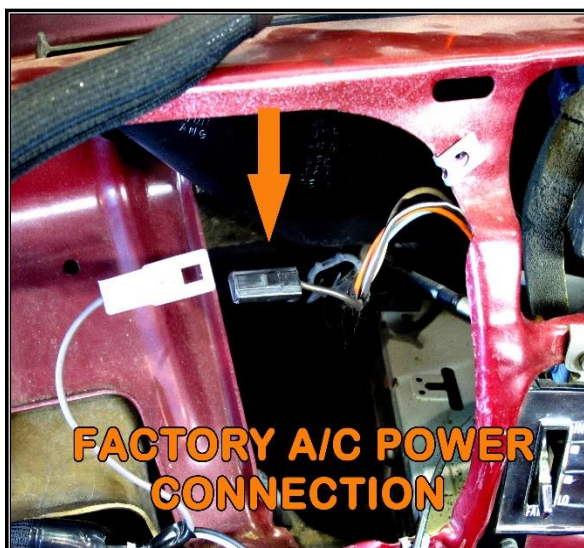

- Locate the inline connector on the factory heat or A/C harness, it will be a single-pin connector with a **BROWN** wire several inches away from the blower switch connection. Plug the **BROWN #904** power wire into this connector on the air conditioning harness.

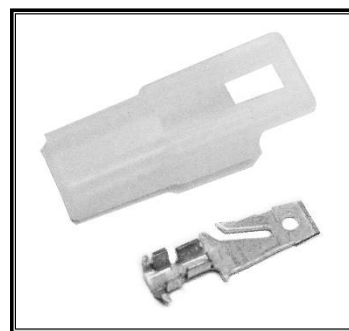

Cigarette Lighter / Power Port

The Cigarette Lighter/Power Port connection on the Painless harness is set up for a universal application since most sockets have been replaced by aftermarket sockets. Typically, the cigarette lighter is more commonly used as a power port to charge and run electronic components requiring a 12vDC power source.

ORANGE: 16-gauge wire, printed, [ACC. SECTION] **#903 CIG. LIGHTER/POWER PORT (BAT)**, this wire comes from the 20-amp CIG LIGHTER fuse and provides a battery power source to a cigarette light/power port.



- Route the **ORANGE #903** wire to the cigarette lighter/power port.
- Cut the wire to length and connect according to one of the following options (see the clock notation below before doing any termination):
 - Ring terminals and bullet/socket/spade style terminals are provided in the parts kit to connect universal aftermarket lighters/power ports. Universal Lighter socket part #56458, seen in the photo, can be found at most local parts stores. A ground wire is needed
 - For those with a factory socket, you can cut the connector from your factory harness. Leave 3" or 4" of wire to create a pigtail and splice it to the **ORANGE #903** wire on the Painless harness. Splices have been provided in the parts kit.

If You Have a Clock

- Retain the cutoff portion of the **ORANGE #903** wire, double it with the wire connecting to the cigarette lighter/power port, and then route this wire to the clock and connect.

Additional Wires

GREY: 18-gauge wire, printed [ACC. SECTION] **#930 PANEL BACKLIGHTING**, this wire provides backlighting to any accessory panels or switches. If you need to light multiple panels, you must splice or chain this wire to the various accessories. Linking or chaining was explained on [page 94](#) in the **Instrument Panel** section. This wire has power anytime the headlight switch is in the Park/Taillights ON or Headlights ON position. This wire/splice can be seen in the [Radio & Accessory Schematic](#) on [page 99](#).

GREY: 18-gauge wire, printed [ACC. SECTION] **#930 GEAR INDICATOR LIGHT**, this wire provides backlighting to gear shift panel. This wire can also be used to power a gear indicator light on floor-mounted shifters. This wire has power anytime the headlight switch is in the Park/Taillights ON or Headlights ON position. This wire/splice can be seen in the [Radio & Accessory Schematic](#) on [page 99](#).

PINK: 16-gauge wire, printed [ACC. SECTION] **#906 ACCESSORY POWER (IGN.)**, this wire provides a switched Ignition power source for an accessory not exceeding 15 amps. In most cases, this wire is used to provide a cooling fan relay a switched 12v source activation. **DO NOT POWER A COOLING FAN WITH THIS WIRE.** If that is the case, re-route and group this wire with the **Front-Lighting Section** (see [page 17 & 35](#)) as fan relays are generally mounted on the inner fender or core support. If the **Pink #906** wire will be used to power some other accessory, re-route the **Pink #906** in the harness to wherever the accessory is located.

Power Windows & Power Locks

Two accessory wires have been provided in the **Accessory Section** for those with power windows and/or power locks. These wires are:

PINK: 12-gauge wire, printed **[ACC. SECTION] #911 WINDOW POWER (IGN)**, this wire provides a switched ignition power source for power windows from the 20-amp PWR WINDOW fuse. This wire provides power to the windows any time the ignition key is in the ACCESSORY or ON/RUN position.

ORANGE: 12-gauge wire, printed **[ACC. SECTION] #910 DOOR LOCK POWER (BAT)**, this wire provides a battery power source, from the 20-amp DOOR LOCKS fuse. This wire provides constant battery power for door locks.

Single-pin connectors and terminals are provided to allow linkage to the connectors found on the power lock/power window wires of the factory harness. These connectors allow you to make a factory-style connection to your factory power lock/power window harness, to aftermarket power lock/power window harnesses, or to a component you are potentially powering with one of these circuits.

- For those installing aftermarket power locks, connect the **ORANGE #910** wire to the wire or switch/relay input that requires a fused battery power source.
- For those installing aftermarket power windows, connect the **PINK #911** wire to the wire or switch/relay input that requires a fused switched ignition power source.

For those reusing the factory power lock/power window harness, the following set of instructions is used to slightly modify the original harness to work with the Painless harness.

- Begin by locating the two connectors on the factory power lock/power window harness that connected to the accessory ports at the fuse block. These connectors use the same terminals provided in the kit that mate to the power lock/power window connectors found on the Painless harness. A simple connector change is all that is needed to re-use the factory power lock/ power window harness with the Painless harness.

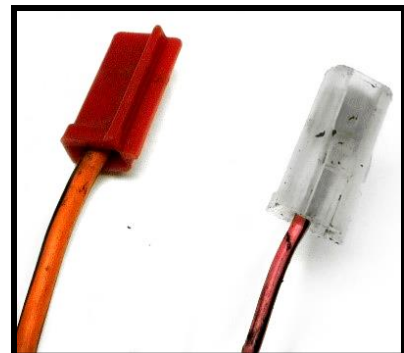
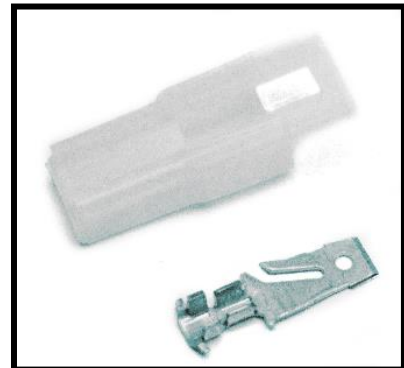

- Using the terminal removal procedure, found on [page 22](#), remove the two fuse block connectors on the factory harness. Remember to pry the locking tang of the terminal back out once the connector is removed. The factory connectors can also be cut from the original harness and the new terminals that are provided with the Painless kit can be installed.

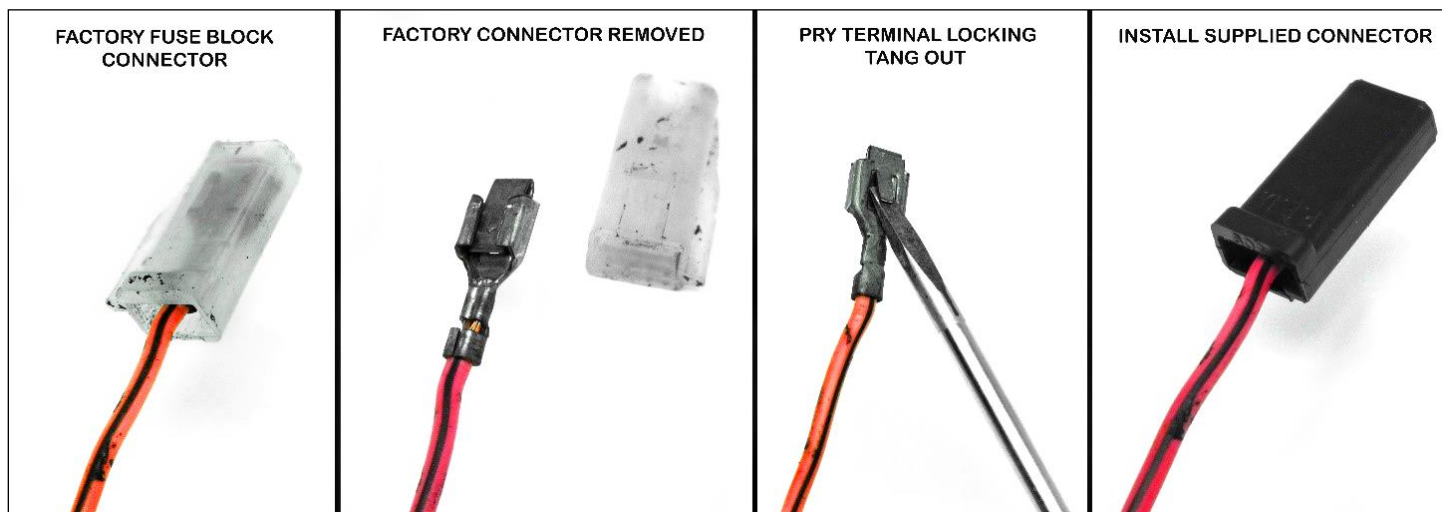

- Install one of the single-pin connectors on each of the factory wires and connect them to the Painless harness. The factory pink/black wires connect to the power window, **PINK #911** wire on the Painless harness. The factory, orange/black wire connects to the power lock, **ORANGE #910** wire on the Painless harness.

NOTES:

PASSENGER COURTESY LIGHT SECTION

Next, connect the remaining wires of the Courtesy Light Section. The left/driver's side was installed on [pages 68 – 70](#).

PASSENGER COURTESY LIGHT

This connection allows the passenger side under the dash/floorboard of the vehicle to be illuminated any time a door is open or when the headlight switch is activating the dome light.

These wires can be seen in the [Dome / Courtesy Light Schematic](#) on [page 70](#), these wires are:

ORANGE: 18-gauge, printed [COURTESY LIGHT] #971 COURTESY LIGHT (BAT), this wire provides power from the 15-amp HAZARD/DOME fuse on the fuse block. This fuse is battery powered and always has power.



WHITE: 18-gauge, printed [COURTESY LIGHT] #961 COURTESY LIGHT GROUND, this is the ground wire that activates the courtesy light. When this wire is grounded, it completes the voltage path and causes the light to illuminate. This ground comes from either the door jamb switch or the headlight switch depending on if the door is opened or the headlight switch is turned to the "DOME LIGHT ON" position.

- Locate a lamp socket and terminals (see above) from the parts kit. This light socket can use either a 63 or 67 series bulb.
- Locate a suitable mounting location under the passenger's side of the dash. The light socket has a small hole in a mounting tab to allow mounting. This kit provides both self-tapping screws and small zip-ties to accommodate the various ways you might affix the socket. You may also use screws that hold existing trim. **Do not mount the socket at this time.**
- Locate the loose **ORANGE #971** wire you doubled at the driver side courtesy light on [page 69](#). Route the wire to where the socket will be mounted on the passenger side and cut to length. **If you have a glove box light, retain the piece of ORANGE #971 wire, double it with the ORANGE wire at the courtesy light.**
- Strip $\frac{1}{4}$ " of insulation from each wire and install the terminals. Crimp the smaller, brass terminal to the **WHITE #961** wire and the larger terminal to the **ORANGE #971** wire.
- Insert the terminals into the connector, install a bulb (not included), and mount the socket.

GLOVE BOX SWITCH

The glove box switch is a simple, plunger activated light that illuminates the inside of the glove box when the glove box door is opened. The glove box switch requires a single power wire to function correctly, as it grounds through its mounting.

- See one of the following methods of connecting to a glove box switch. Both methods require installing the terminal and connector (seen in the photo to the right) after the **ORANGE #971** wire has been routed and cut to length.

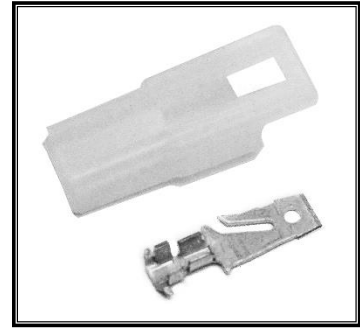

Factory Switch: The factory wire for the switch has a single terminal installed into the side of the switch. This wire can be difficult to remove, and, chances are, you will break the switch trying to remove it. Painless recommends cutting the wire going to the switch and installing a terminal and connector, as seen in the photo below. This allows the connector shown above to be installed on the Painless harness and plug right in.

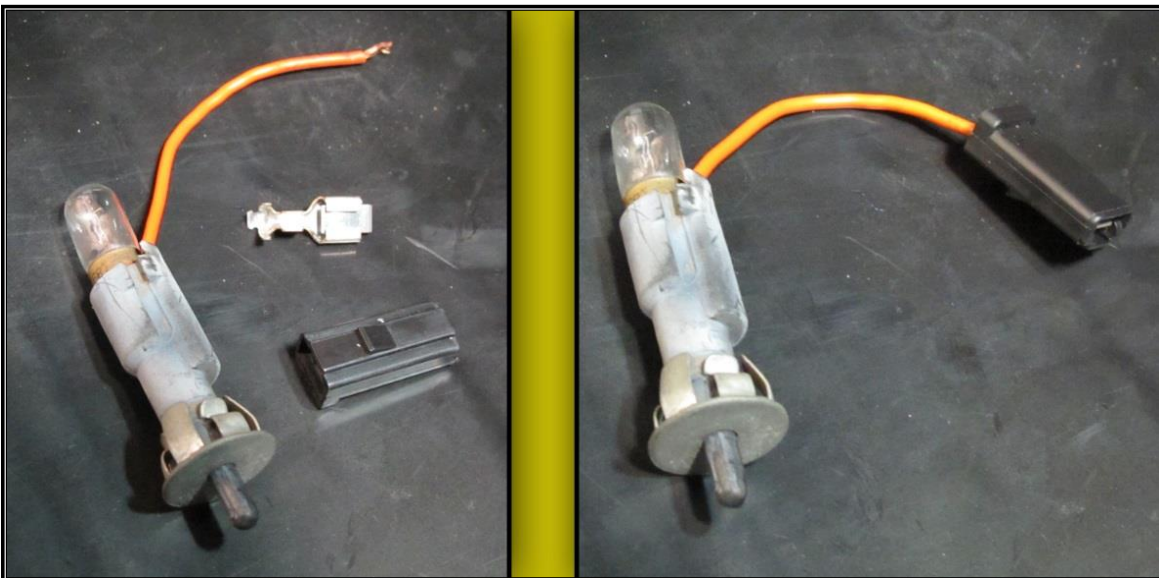

- With the factory switch now modified, install it into the dash and connect it to the **ORANGE #971** wire on the Painless harness.

You can use the holes found in the edge of the glove box opening and small zip-ties, included with the kit, to help secure the wire.

PASSENGER SIDE DOOR JAMB SWITCH

The passenger side door jamb switch is the last connection on the passenger side of the vehicle's interior.

The door jamb switches provide a ground activation for the courtesy lights and dome light. When the door is opened, the plunger on the switch extends out as it is no longer being pushed in by the door. When the plunger extends, the contact point on the back of the switch contacts the body of the switch, which is grounded through the mounting into the metal door jamb. This grounding gives the wire attached to the switch a ground source which will then cause the interior lights to turn on.

Locate the wire in the courtesy light section intended for the passenger door jamb switch. It is:

WHITE: 18-gauge wire, printed **[COURTESY LIGHT] #961 PASSENGER SIDE DOOR JAMB SWITCH**, this wire is spliced to other white wires leading to the dome light, courtesy light, headlight switch, and the driver's side door jamb switch. This wire is grounded anytime either door is opened, or when the headlight switch knob is rotated to the "DOME LIGHT ON" position. This wire can be seen in the [Dome / Courtesy Light Schematic](#) on [page 70](#).

- Route the **WHITE #961** wire to the passenger's side door jamb switch and use an insulated terminal from the parts kit that fits your switch to connect it. If you find that your door jamb switch has 2 tabs, it does not matter which tab the **#961** connects to.

If this is a new build/restoration or your original switches are just in bad shape and new switches are needed, Painless offers factory style, GM jamb switches: [part #80170](#). Please note that [part #80170](#) is for 1 switch, and each door requires a switch.

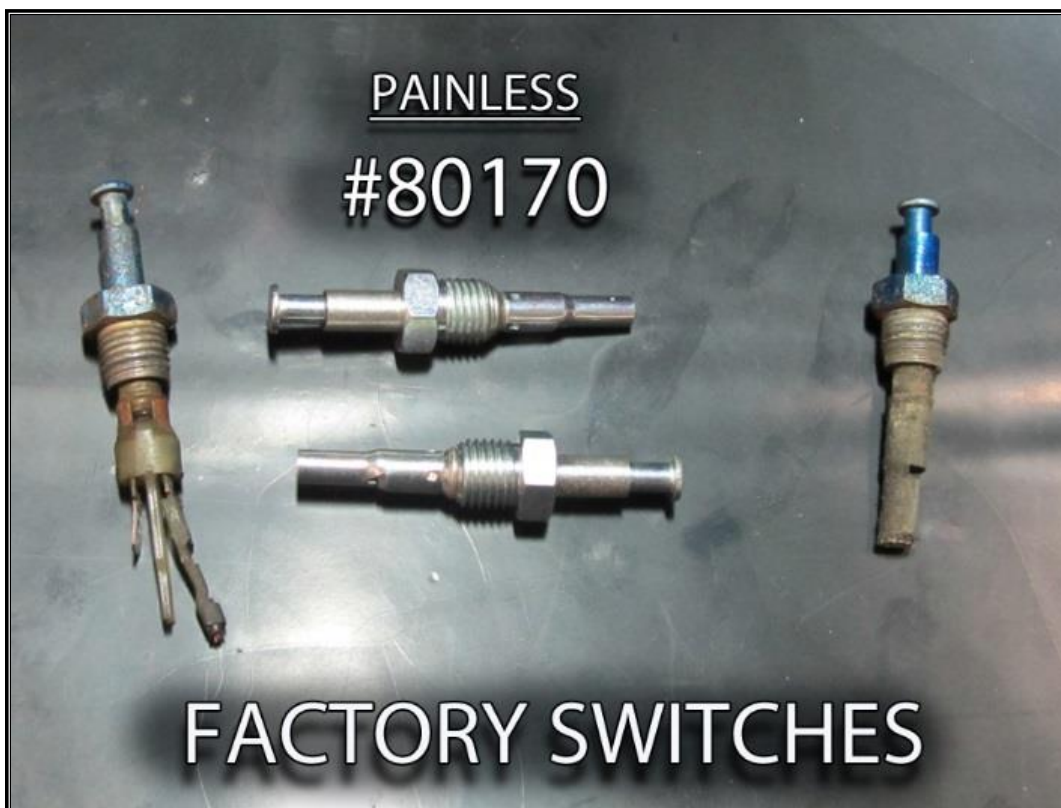

TAIL SECTION

The **Tail Section** wires are the last group to be connected. This group of wires connect to things like the right & left turn signals, taillights, reverse lights, license plate light, and fuel level sending unit. All the wires found in the **Tail Section** can be seen in the schematics found on [pages 117 & 118](#).

Route the wires with the print reading "TAIL SECTION" to the rear of the vehicle. Make sure to avoid pinch points around door/trunk hinges and moving parts like window regulators.

- Before making any connections, locate the separate rear ground harness and route it across the rear of the vehicle. The [Tail Section Ground Schematic](#) can be found on [page 116](#).

DOME LIGHT

The dome light has constant battery power applied to it. This light, along with the under the dash courtesy lights, are ground activated by the door jamb switches and by turning the headlight switch to the DOME LIGHT ON position. These wires can be seen in the tail section schematics on [pages 117 & 118](#), they are:

ORANGE: 18-gauge wire, printed **#971 DOME LIGHT (BAT)**, this power wire comes from a splice with the **ORANGE #971 COURTESY LIGHT POWER (BAT)** wire and a power wire leading to the 15 amp HAZARD/DOME fuse on the fuse block. This fuse has battery power and is "hot" at all times. This wire can also be seen in the [Dome / Courtesy Light Schematic](#) on [page 70](#).

WHITE: 18-gauge wire, printed **#961 DOME LIGHT GROUND**, this wire is the ground wire that activates the dome light. When this wire is grounded it completes the voltage path causing the light to illuminate. This ground will come from either a door jamb switch or the headlight switch. This wire can also be seen in the [Dome / Courtesy Light Schematic](#) on [page 70](#).

- In most cases, these wires will attach to the factory dome light wires. The factory wires coming from the dome light can usually be seen in the trunk, on the driver's side, near the trunk hinge. A connector and terminals, seen to the right, have been provided to connect the Painless harness to the factory pigtail coming from the dome light.



- If you do not have a factory pigtail, there has been ample length supplied to allow routing of the **ORANGE #971** and the **WHITE #961** to the dome light fixture. In most cases, this will require the headliner of the vehicle to be removed. Terminals have been provided to allow connecting to your existing dome light fixture.

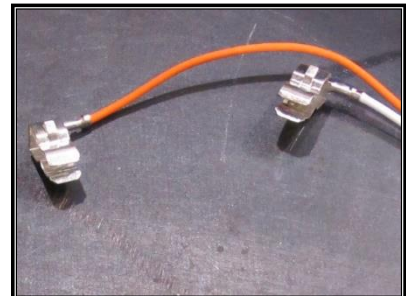

AFTERMARKET AMPLIFIER

For those with an audio sound system, a wire has been provided in the Painless harness to allow for amplifier activation. This wire is only needed if you have an amplifier:

BLUE: 18-gauge, printed **[RADIO SECTION] #999 AMP TURN ON [TAIL SECTION]**, this is a switched power source that comes from the radio/head unit and not a power source that comes directly from the fuse block.

- Route and connect the **#999** wire to the “Remote Turn On” terminal of the amplifier.

If you have multiple amplifiers, double up the cutoff portion of **#999** with the **#999** at the first amp and route it to the “Remote Turn On” terminal of the second amplifier.

LEFT SIDE MARKER LIGHT

The left side marker light is the next connection. The marker light is activated by a power source coming from the headlight switch. This light illuminates any time the headlight switch is in the *PARK* or *ON* position.

The park light requires two wires to work properly, they are:

BROWN: 18-gauge wire, printed **[TAIL SECTION] #929 LEFT MARKER LIGHT**, this is a power wire for the park or marker light function. This wire has power anytime the headlight switch is in the Park/Taillights ON or Headlights ON position. This wire, along with all the other wires and splices it is associated with, can be seen in the tail section schematics on [pages 117 & 118](#).

BLACK: 18-gauge wire, printed **#969 MARKER LIGHT GROUND**, this wire provides a ground source for the park light and comes from a splice that is tied to a series of other splices that make up the rear ground harness. This wire, along with all the other ground wires and splices, can be seen in the diagram on [page 116](#).

- The parts kit provides a factory-style ¼-turn socket and splices. This socket requires a wedge base 194 bulb; not provided.
- Route the side marker wires to the marker light and cut to length. Strip ¼” from the wires of the Painless harness and the wires on the socket. Splice the 2 wires of the Painless harness to the wires on the socket. It does not matter which wire goes where.

LEFT TURN / BRAKE LIGHTS

Connection to the turn signal/brake lights depend on if your vehicle has integrated or separate turn/brake signals; both are explained on [page 77](#). Furthermore, if your light sockets ground themselves through the mounting, a ground wire, seen in the [Tail Section Ground Schematic](#) on [page 116](#), may not be needed.

To begin making connections to the turn/brake lights, locate the 4 wires in the tail section dedicated for these functions, they are:

YELLOW: 16-gauge wire, printed **[TAIL SECTION] #949 LEFT TURN / BRAKE**, this wire provides power to the left turn signal. This wire has power anytime the turn signal is in the down/left position and the ignition switch is in the *ON/RUN* position. For vehicles with integrated turn/brake signals, this wire is also the brake light power. The wire has power anytime the brake pedal is pressed or anytime the hazard switch is activated. This wire can be seen in tail section schematics on [pages 117 & 118](#).

ORANGE: 18-gauge wire, printed **[TAIL SECTION] #950 BRAKE LIGHT POWER (SEPARATE / 3RD BRAKE ONLY)**, this wire provides power to the brake lights on vehicles with separate turn/brake lights, or a third brake light, and has power anytime the brake pedal is pressed or the hazard switch is activated. This wire can be seen in the [Tail Section w/ Separate Turn/Brake Lights](#) on [page 118](#).

Notice there is only one separate brake light wire going to the Tail Section. Since Painless has no idea if this wire will be needed in your particular application, and since it is not used in most applications, we only provide one wire to prevent additional unused power wires to be taped up in the harness. If separate turn brake sockets are used, **it will be up to you to splice or link this brake light power to both brake lights.**

If you have integrated turn/brake lights, install an insulated cap on this ORANGE #950 wire and tape it up into the harness, this wire will not be used.

BLACK: 18-gauge wire, printed **#969 TURN SIGNAL GROUND**, this wire provides a ground source for separate turn signal lights and comes from a splice that is tied to a series of other splices that make up the rear ground harness. This wire, along with all the other ground wires and splices, can be seen in the diagram on [page 116](#).

- Your factory turn signal sockets must be re-used. Factory style terminals and button contacts have been supplied to allow easy re-use of your sockets. If you find that these terminals do not work with your sockets, you will need to splice the Painless harness wires to the factory wires coming from your sockets.
- Loosely route the **YELLOW #949** turn signal wire to the turn signal. On integrated brake/ turn housings/assemblies with a dual filament bulb, this will be the brighter filament. If you have separate turn/brake lights this will connect to the socket with the yellow lens.



- If you have separate turn/brake lights, route the **ORANGE #950** brake light wire to the closest brake light as well. On housings/assemblies with a dual filament bulb, this will be the brighter filament.
- If your housing requires a ground source, ground wires need to be connected at this time. If a ground is not needed, either remove this **BLACK #969** wire from the harness or connect it to a chassis ground source.
- Cut the wires to length and connect to the appropriate contact/wire in the housings/assemblies. Consult the manufacturer's instructions if you are using aftermarket assemblies. Splices are provided to make these connections.

TAILLIGHTS

In most cases, your rear exterior lights have at least one housing/assembly with a dual filament bulb. The taillight connections attach to the dimmest filament(s) of this type of housing/assembly. Two wires are provided in the tail section for these connections, they are:

BROWN: 16-gauge wires, printed **[TAIL SECTION] #929 LEFT TAILLIGHT**, this wire provides the taillight power. This wire receives power from the headlight switch and has power anytime the headlight switch is pulled into the PARK/TAILLIGHT ON and HEADLIGHT ON positions. This wire can be seen in the [Tail Section Schematics](#) on [pages 117 & 118](#).

BLACK: 18-gauge wire, printed **#969 TAILLIGHT GROUND**, this wire provides a ground source for the brake light. It comes from a splice that is tied to a series of other splices that make up the rear ground harness. This wire, along with all the other ground wires and splices, can be seen in the diagram on [page 116](#).

- Your factory taillight sockets must be re-used. Factory style terminals and button contacts are supplied to allow easy re-use of your sockets. If you find that these terminals do not work with your sockets, you will need to splice the Painless harness wires to the factory wires coming from your sockets.
- Loosely route the **BROWN #929** taillight wire to the taillight. On housings/assemblies with a dual filament bulb, this will be the dimmer filament.
- If the socket requires a ground, connect the **BLACK #969** to the ground on the socket. If a ground is not needed, either remove this **BLACK #969** wire from the harness or connect it to a chassis ground source.
- Cut the wires to length and connect to the appropriate contact in the housings/assemblies. Consult the manufacturer's instructions if you are using aftermarket assemblies.

REVERSE LIGHT

Two wires are provided in the tail section for reverse light connections, they are:

LT. GREEN: 18-gauge wire, printed **[TAIL SECTION] #956 LEFT REVERSE LIGHT POWER**, this wire provides power to the reverse or back up lights. This wire receives power from the reverse switch and has power anytime the shifter is in the “REVERSE” position with the ignition switch in the “ON/RUN” position.

BLACK: 18-gauge wire, printed **#969 REVERSE LIGHT GROUND**, this wire provides a ground source for the brake light and comes from a splice that is tied to a series of other splices that make up the rear ground harness. This wire, along with all the other ground wires and splices, can be seen in the diagram on [page 116](#).

- Your factory reverse light sockets must be re-used. Factory style terminals and button contacts have been supplied to allow easy re-use of your sockets. If you find that these terminals do not work with your sockets, you will need to splice the Painless harness wires to the factory wires coming from your sockets.
- Loosely route the **#956** reverse light wire to the reverse light.
- If the socket requires a ground, connect the **BLACK #969** to the ground on the socket. If a ground is not needed, either remove this **BLACK #969** wire from the harness or connect it to a chassis ground source.
- Cut the wires to length and connect them to the appropriate contact on the housings/assemblies. Consult the manufacturer’s instructions if you are using aftermarket assemblies.
- If your vehicle does not have reverse lights, tape them up into the harness, these wires will not be used. The wires only have power if they are connected to a reverse switch. The wires can also be removed from the harness if it is not being used.

FUEL SENDING UNIT

The fuel level sending unit sends a ground signal to the fuel level gauge. The float inside the tank moves up and down with the level of fuel in the tank. This raising and lowering of the fuel level moves an arm/contact across a resistor of the sending unit. This sends a resisted signal to the fuel level gauge. The amount of resistance the gauge sees is evident based on the reading of the gauge. For the fuel gauge to work properly, the fuel level sending unit operating range must match the gauges operating range. One wire is included in this Painless kit for this function, it is:

TAN: 18-gauge wire, printed **[TAIL SECTION] #939 FUEL LEVEL SIGNAL [INSTRUMENT PANEL SECTION]**, this wire sends the ground signal from the fuel level sending unit to the fuel level gauge.

- Route the **TAN #939** wire to the fuel level sending unit.

*Note: **If a hole must be drilled in the trunk pan, be sure to not puncture the fuel tank.** Also, before a hole is drilled, make sure there is no other way to get the **#939** wire to the fuel sender.

- The parts kit provides insulated terminals to make this connection.
- **The sending unit must be grounded to work properly;** Painless does not offer a wire specifically for this. Some sending units have a tab for a ground connection while others may rely on the sending unit mounting. If your sending unit has a ground tab, run a wire from a clean chassis ground source to this tab.

If you do not have a ground tab, run a ground wire from a clean chassis ground source to one of the mounting bolts of the sending unit. Do not rely on a ground through the mounting of the sending unit to the tank.

FUEL PUMP

RED: 16-gauge wire, printed [TAIL SECTION] #947 FUEL PUMP (IGN), this wire provides a power source to an electric fuel pump. This wire comes from the 15-amp, FUEL PUMP fuse on the fuse block and only has power when the ignition switch is in the ON/RUN position and the START position.

- If a mechanical pump is being used, this wire can be used to power any component needing a switched ignition power source, not exceeding 15 amps.
- **DO NOT USE THIS WIRE FOR AN EFI PUMP.** An EFI fuel pump with a psi of 40 lbs. or more require a fuel pump relay and not this wire.
- Once in the trunk area, route this #947 out of the tail panel with the fuel sending unit wire.
- Using an insulated terminal that matches the connection your pump requires, connect the **RED #947** wire to the power or + post/tab/wire of the fuel pump. The parts kit provides insulated terminals to make these connections.
- At this time, you will need to provide a ground wire. This harness does not provide a ground wire for an electric fuel pump. However, a ground can be easily connected using insulated terminals from the parts kit and a length of scrap wire created during a previous connection. Simply connect the ground or - post/tab/wire of the fuel pump to one of the mounting bolts holding the fuel pump to the frame/body.

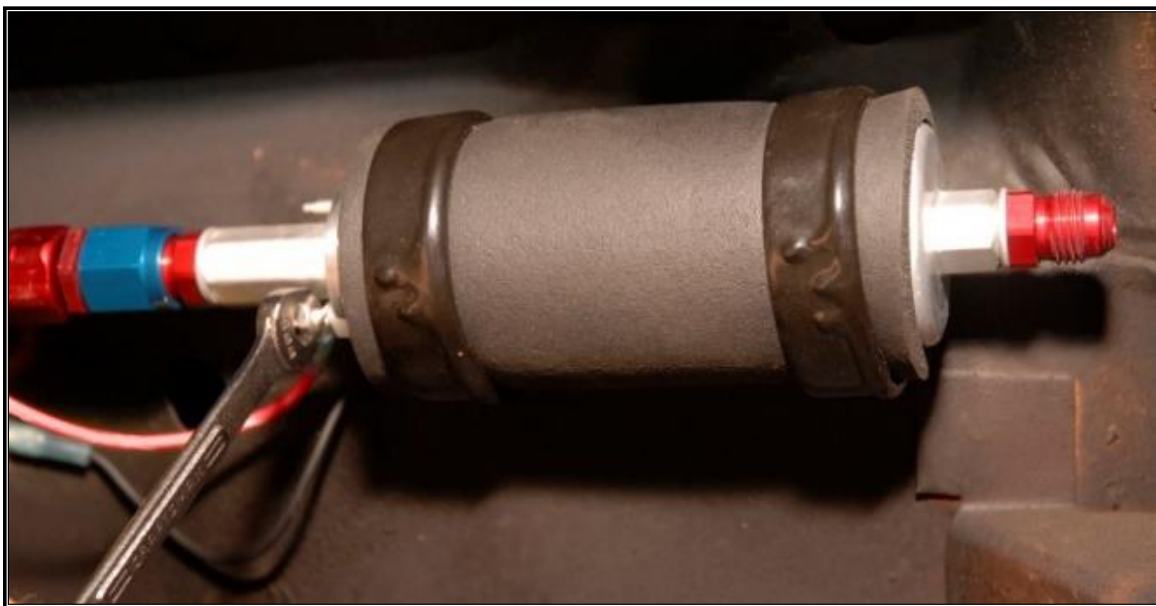

LICENSE PLATE LIGHT

The license plate light is the next connection that needs to be made. This light is tied to the rear marker lights and taillights and will illuminate the license plate when the headlight switch is in the park light “ON” or headlight “ON” positions.

BROWN: 18-gauge wires, printed **[TAIL SECTION] #929 LICENSE PLATE LIGHT**, this is a power wire for the license plate light function. This wire has power anytime the headlight switch is in the park light ON or headlight ON positions. This wire can be seen in the tail section schematics on [pages 117 & 118](#).

BLACK: 18-gauge wires, printed **#969 LICENSE PLATE LIGHT GROUND**, this wire provides a ground source for the license plate lights and comes from a splice that is tied to a series of other splices that tie all the grounds in this harness together. This wire, along with all the other ground wires and splices, can be seen in the [Tail Section Ground](#) diagram on [page 116](#).

- In most cases, your license plate light will have a socket/bullet terminal connection. Insulated terminals have been provided in the parts kit to connect to these types of plate lights. You can cover the insulated terminal with heat-shrink once connected to clean up the look of this connection since colored insulated terminals can often look out of place.
- Your factory light socket must be re-used. Button contacts are supplied to allow easy re-use of your sockets. If you find that these terminals do not work with your sockets, you will need to splice the Painless harness wires to the factory wires coming from your socket.

RIGHT TURN/ BRAKE/ REVERSE/ MARKER LIGHTS

The connections mentioned above all connect in the same manner as those on the left/driver side. The only difference you will find is the turn signal wire for the right turn signal is a different color than the one used for the left turn signal. The right turn signal will be:

GREEN: 16-gauge wire, printed **[TAIL SECTION] #948 RIGHT TURN/BRAKE**, this wire provides power to the right turn signal. This wire has power anytime the turn signal is in the up/right position and the ignition switch is in the *ON/RUN* position. For vehicles with integrated turn/brake signals, this wire is also the brake light power and has power anytime the brake pedal is pressed, or the hazard switch is activated. This wire can be seen in the tail section schematics on [pages 117 & 118](#).

GROUND

The ground connection in the rear ground harness ties all the grounds found in the rear ground harness to a common ground source. One wire makes up this connection, it is:

Black: 14-gauge wire, printed **#969 TO CHASSIS GROUND**, this wire provides a ground source for the **Rear Ground Harness** from a splice that is tied to another splice that ties all the grounds in this rear harness together. This wire, along with all the other ground wires and splices, can be seen in the [Tail Section Ground](#) diagram below.

- Using a ring terminal from the parts kit, connect this #969 wire to a clean ground source or the negative side of the battery.

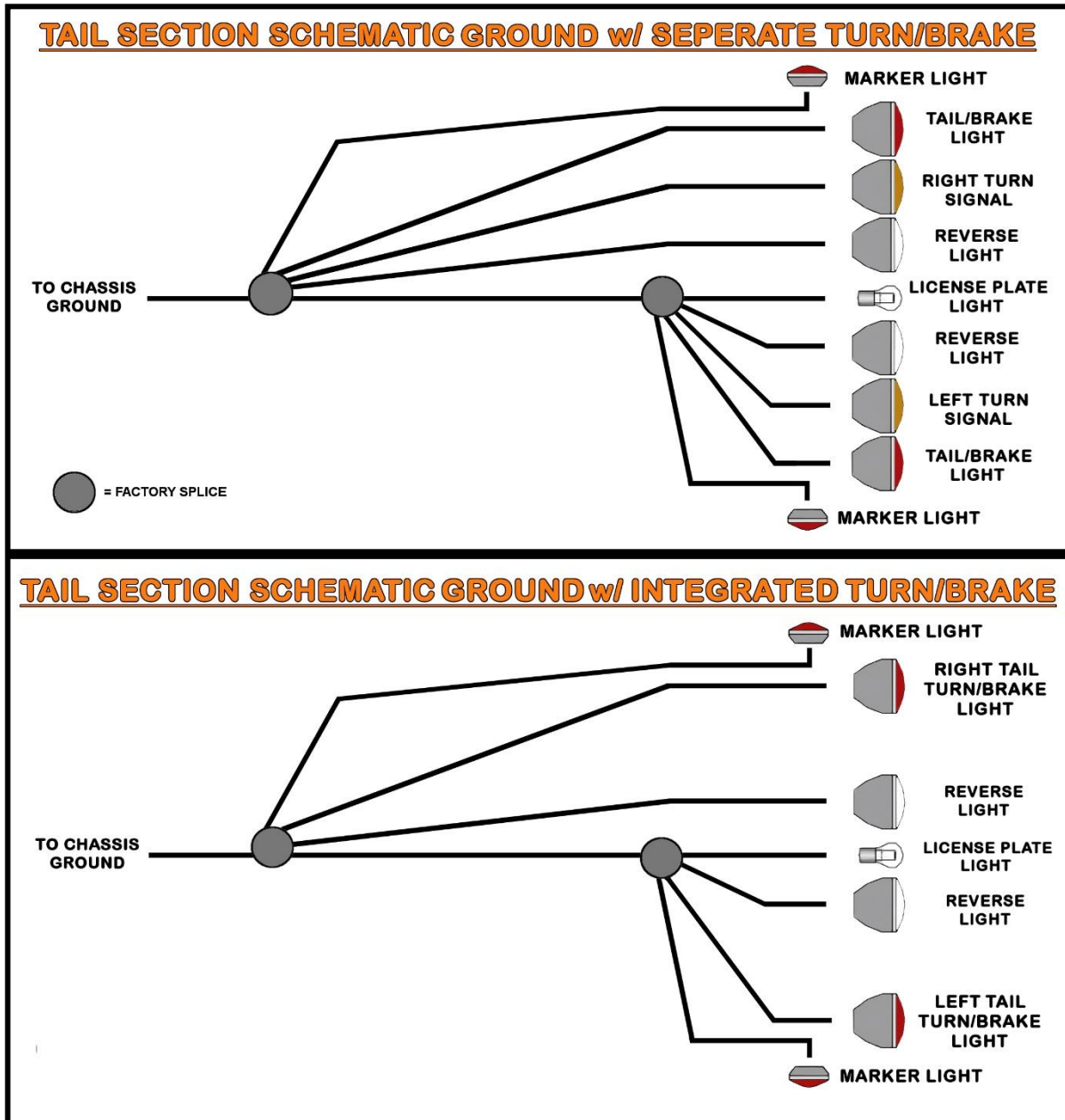

TAIL SECTION SCHEMATIC W/ SEPERATE TURN/BRAKE

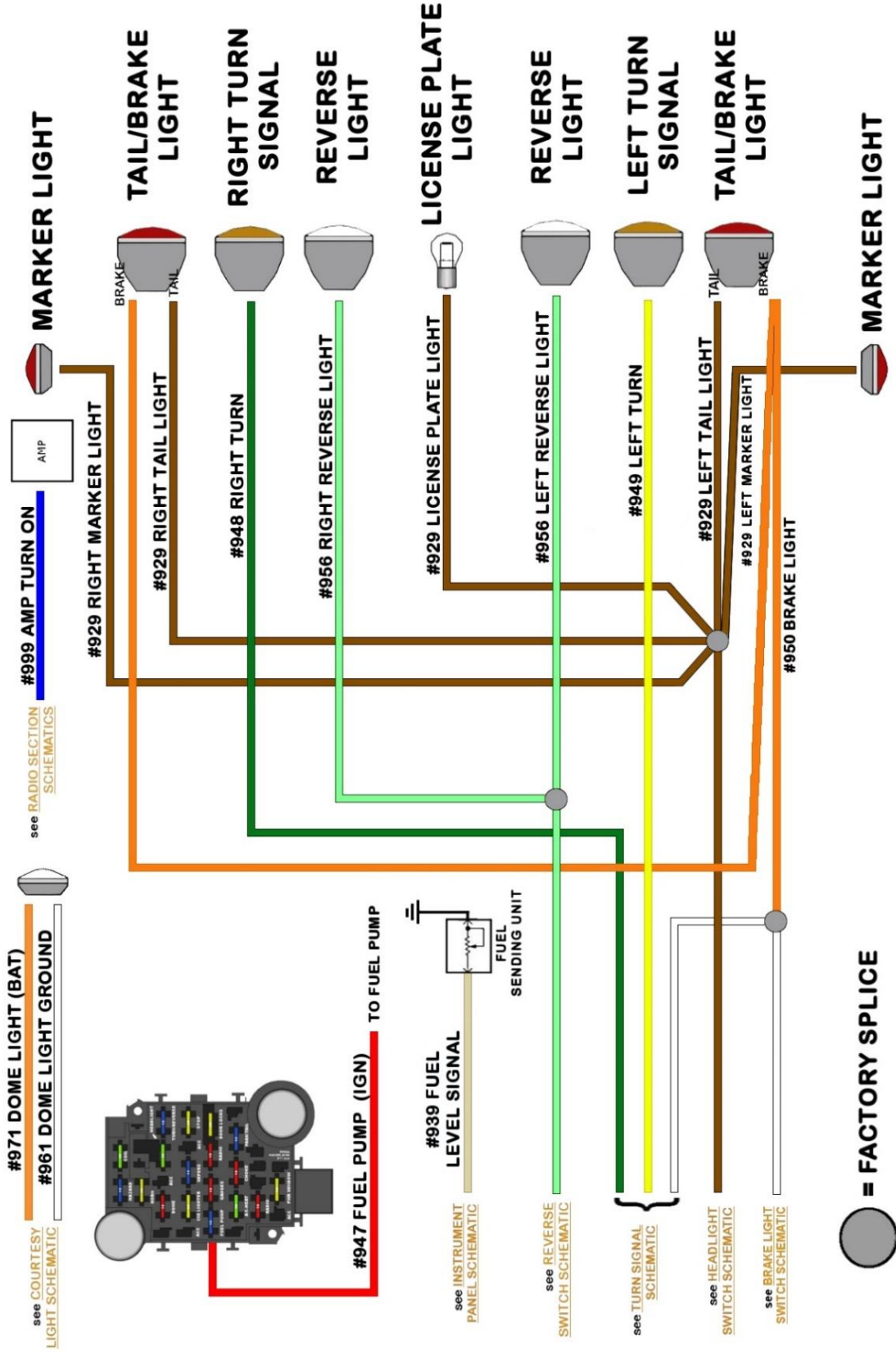

TESTING THE SYSTEM

Use a small (10 amp or less) battery charger to power up the vehicle for the first time to test the circuits. If there is a problem anywhere, the battery charger's low amperage and internal circuit breaker will provide circuit protection.

- Make sure the negative (-) battery cable is connected to the frame or engine block, and make sure there is a ground between the engine and frame. **The negative battery cable should still be disconnected from the Battery**

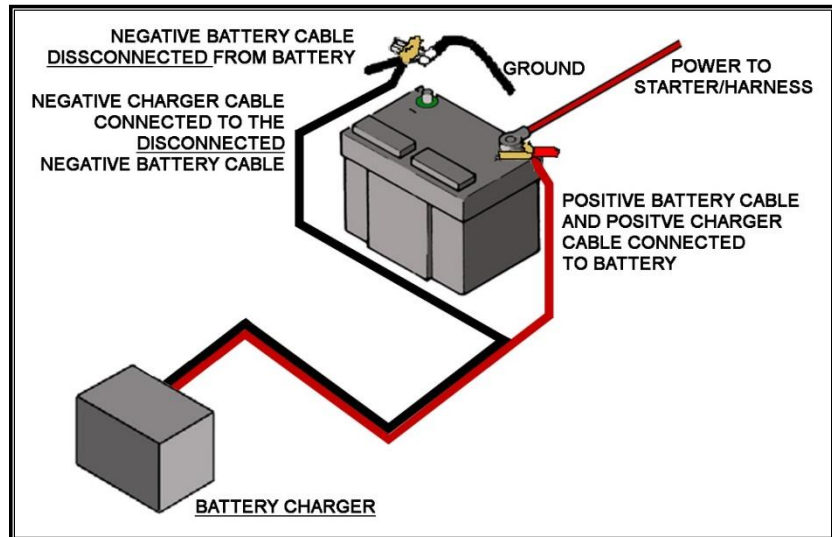

- Connect the positive (+) battery cable to the positive side of the battery and make sure the other end of this cable is connected to the B+ side of the starter solenoid.
- At this point connect the **RED #915** from the MIDI fuse to the positive side of the battery, either through the starter lug or the battery lug.
- Connect the Battery Charger's NEGATIVE cable to the automobile chassis, engine block, or the disconnected negative battery cable. **Do NOT connect the Battery Charger's NEGATIVE cable to the Battery.**
- Connect the Battery Charger's POSITIVE cable to the automobile's positive battery terminal lug.
- INDIVIDUALLY turn on each light, ignition, wiper circuit, etc. and check for proper operation. Turn off each component before testing another.

Note: If you try to test more than one circuit at a time, the charger will not provide enough amperage for each circuit to work correctly.

- After all circuits have been checked, disconnect the battery charger and attach the vehicle's negative (ground) battery cable to the battery.
- Once testing is complete, re-install any panels, lens, or other parts that were removed during the harness installation. You are now finished installing this Painless Harness, congratulations!

WIRE INDEX

- The index is listed in the same order in which the manual instructed components to be connected.
- The **BLUE** descriptions indicate sections found throughout the harness.
- **ORIGIN** indicates where the opposite end of this wire is.

FRONT LIGHT SECTION

Color	Gauge	Wire Print	Origin
Blue	16	#925 RIGHT FRONT TURN SIGNAL	Turn Switch
Light Blue	16	#926 LEFT FRONT TURN SIGNAL	Turn Switch
Tan	14	#909 RIGHT LOW BEAM	Dimmer Switch
Tan	14	#909 LEFT LOW BEAM	Dimmer Switch
Brown	18	#927 RIGHT PARK LIGHTS	Headlight Switch
Brown	18	#927 LEFT PARK LIGHTS	Headlight Switch
Light Green	14	#908 RIGHT HIGH BEAM	Dimmer Switch
Light Green	14	#908 LEFT HIGH BEAM	Dimmer Switch
Green	14	#924 HORN	Horn Relay

WIPER MOTOR SECTION

Color	Gauge	Wire Print	Origin
Black	18	#979 LOW/PARK	Wiper Switch
Light Blue	18	#977 HIGH	Wiper Switch
Blue	18	#984 WASHER PUMP	Wiper Switch

ENGINE SECTION

Color	Gauge	Wire Print	Origin
Pink	16	#920 COIL POWER (IGN)	Fuse Block
Green	18	#921 COOLANT TEMP SIGNAL	Instrument Panel
Lt.Blue/Black	18	#922 OIL PRESSURE SIGNAL	Instrument Panel
Brown	18	#923 TACHOMETER SIGNAL	Instrument Panel
Red	18	#954 ELECTRIC CHOKE (IGN)	Fuse Block
Tan/White	18	#962 BRAKE WARNING SWITCH	Instrument Panel

MIDI SECTION

Color	Gauge	Wire Print	Origin
Red	8	#916 BATTERY POWER SOURCE (MIDI FUSE)	Fuse Block

ALTERNATOR SECTION

Color	Gauge	Wire Print	Origin
Brown	16	#914 REGULATOR POWER (IGN)	Fuse Block
Red	14	#995 REGULATOR POWER (BAT)	Fuse Block

DIMMER SWITCH SECTION

Color	Gauge	Wire Print	Origin
Light Green	14	#908 HIGH BEAM	Headlight Section
Tan	14	#909 LOW BEAM	Headlight Section
Blue/Yellow	14	#907 DIMMER SWITCH	Headlight Switch

COURTESY LIGHT SECTION

Color	Gauge	Wire Print	Origin
Orange	18	#971 COURTESY LIGHT POWER (BAT)	Fuse Block
White	18	#961 DRIVER SIDE DOOR JAMB SWITCH	Headlight Switch
White	18	#961 COURTESY LIGHT GROUND	Headlight Switch
White	18	#961 PASSENGER SIDE DOOR JAMB SWITCH	Headlight Switch

HEADLIGHT SWITCH SECTION

Color	Gauge	Wire Print	Origin
Red	12	#928 HEADLIGHT SWITCH POWER (BAT)	Fuse Block
Orange	14	#959 HEADLIGHT SWITCH POWER (BAT)	Fuse Block
Blue/Yellow	14	#907 DIMMER SWITCH	Dimmer Switch
Brown	18	#927 FRONT PARK LIGHTS	Headlight Section
Green	16	#930 GAUGE/PANEL LIGHTING	Instrument Panel
Brown	16	#929 TAIL LIGHTS	Tail Section
White	18	#961 DOME/COURTESY LIGHT ACTIVATION	Courtesy Light Section

WIPER SWITCH SECTION

Color	Gauge	Wire Print	Origin
Black	18	#979 LOW/PARK	Wiper Motor
Light Blue	18	#977 HIGH	Wiper Motor
Blue	18	#984 WASHER PUMP	Wiper Motor

BRAKE SWITCH SECTION

Color	Gauge	Wire Print	Origin
Orange	16	#917 BRAKE SWITCH (BATTERY)	Fuse Block
White	16	#918 BRAKE SWITCH OUTPUT	Turn Signal Switch

TURN SIGNAL SWITCH SECTION

Color	Gauge	Wire Print	Origin
White	16	#918 BRAKE SWITCH INPUT	Brake Switch
Blue	16	#925 RIGHT FRONT TURN SIGNAL	Headlight Section
Light Blue	16	#926 LEFT FRONT TURN SIGNAL	Headlight Section
Blue	18	#938 RIGHT TURN INDICATOR	Instrument Panel
Light Blue	18	#937 LEFT TURN INDICATOR	Instrument Panel
Green	16	#948 RIGHT TURN/BRAKE	Tail Section
Yellow	16	#949 LEFT TURN/BRAKE	Tail Section
Brown	16	#951 HAZARD SWITCH POWER (BAT)	Fuse Block
Purple	16	#952 TURN SIGNAL SWITCH POWER (IGN)	Fuse Block
Black	18	#963 HORN RELAY GROUND ACTIVATION	Fuse Block

IGNITION SWITCH SECTION

Color	Gauge	Wire Print	Origin
Red (10413 only)	12	#934 IGNITION SWITCH POWER (BAT)	Fuse Block
Red	12	#934 IGNITION SWITCH POWER (BAT)	Fuse Block
Orange	12	#933 IGN POWER TO FUSE BLOCK	Fuse Block
Brown	14	#932 ACCESSORY POWER	Fuse Block
Pink	16	#931 IGN POWER TO "COIL" FUSE	Fuse Block
Purple	12	[IGNITION SWITCH] #919 STARTER SOLENOID (START) [NSS]	NSS

EMERGENCY BRAKE SWITCH SECTION

Color	Gauge	Wire Print	Origin
Tan/White	16	#962 EMERGENCY BRAKE SWITCH	Instrument Panel

REVERSE SWITCH SECTION

Color	Gauge	Wire Print	Origin
Pink	18	#958 REVERSE SWITCH POWER (IGN)	Fuse Block
Light Green	18	#956 OUTPUT TO REVERSE LIGHTS	Tail Section

NEUTRAL SAFETY SWITCH SECTION

Color	Gauge	Wire Print	Origin
Purple	12	[NSS] #919 STARTER SOLENOID (START)	Ignition Switch
Purple	12	[STARTER SOL.] #919 STARTER SOLENOID (START)	Starter

INSTRUMENT PANEL SECTION

Color	Gauge	Wire Print	Origin
Blue	18	#938 RIGHT TURN INDICATOR	Turn Switch
Light Blue	18	#937 LEFT TURN INDICATOR	Turn Switch
Pink	18	#935 GAUGE POWER (IGN)	Fuse Block
Green	18	#921 COOLANT TEMP SIGNAL	Engine Section
Lt.Blue/Black	18	#922 OIL PRESSURE SIGNAL	Engine Section
Brown	18	#923 TACHOMETER SIGNAL	Engine Section
Tan	18	#939 FUEL LEVEL SIGNAL	Tail Section
Grey	18	#930 INSTRUMENT PANEL LIGHTING	Headlight Switch
Light Green	18	#936 HIGH BEAM INDICATOR	Dimmer Switch

ACCESSORIES & RADIO SECTION

Color	Gauge	Wire Print	Origin
Yellow	18	#940 RADIO POWER (BAT)	Fuse Block
Red	18	#941 RADIO POWER (IGN)	Fuse Block
Blue	18	#999 AMP TURN ON	Tail Section
Grey	18	#930 RADIO BACK LIGHTING	Headlight Switch
Pink	16	#906 ACCESSORY POWER (IGN)	Fuse Block
Brown	14	#904 HEATER/AC POWER (IGN)	Fuse Block
Orange	16	#903 CIG. LIGHTER/POWER PORT (BAT)	Fuse Block
Yellow	16	#905 WIPER SWITCH POWER (IGN)	Fuse Block
Grey	18	#930 PANEL BACKLIGHTING	Headlight Switch
Pink	12	#911 WINDOW POWER (IGN)	Fuse Block
Orange	12	#910 DOOR LOCK POWER (BAT)	Fuse Block

TAIL SECTION

Color	Gauge	Wire Print	Origin
Yellow	16	#949 LEFT TURN/BRAKE	Turn Switch
Green	16	#948 RIGHT TURN/BRAKE	Turn Switch
Brown	16	#929 RIGHT TAIL LIGHT	Headlight Switch
Brown	16	#929 LEFT TAIL LIGHT	Headlight Switch
Brown	18	#929 LEFT MARKER LIGHT	Headlight Switch
Brown	18	#929 RIGHT MARKER LIGHT	Headlight Switch
Brown	18	#929 LICENSE PLATE LIGHT	Headlight Switch
Orange	18	#950 BRAKE LIGHT (SEPARATE/3RD BRAKE ONLY)	Brake Switch
Light Green	18	#956 RIGHT REVERSE LIGHT	Reverse Switch
Light Green	18	#956 LEFT REVERSE LIGHT	Reverse Switch
Tan	18	#939 FUEL LEVEL SIGNAL	Instrument Panel
Blue	18	#999 AMP TURN ON	Acc. & Radio Section
Red	16	#947 FUEL PUMP (IGN)	Fuse Block
Orange	18	#971 DOME LIGHT (BAT)	Coutesy Light Section
White	18	#961 DOME LIGHT GROUND	Coutesy Light Section

Painless Performance Limited Warranty **and Return Policy**

Chassis harnesses, fuel injection harnesses, and Trail Rocker units are covered under a lifetime warranty.

All other products manufactured and/or sold by Painless Performance are warranted to the original purchaser to be free from defects in material and workmanship under normal use. Painless Performance will repair or replace defective products without charge during the first 12 months from the purchase date. No products will be considered for warranty without a copy of the purchase receipt showing the seller's name, address, and date of purchase. You must return the product to the dealer you purchased it from to initiate warranty procedures.

Bulkhead Template for Vehicles with No Bulkhead Hole

The dimension photo below shows how you can cut the bulkhead hole clean and precise using a $1\frac{1}{4}$ " hole saw to cut 4 holes, using a jigsaw or cut off wheel to connect the outsides of the $1\frac{1}{4}$ " holes and using a $\frac{1}{4}$ " drill bit for the fuse block mounting holes. Mark the centers of all 6 holes (the $1\frac{1}{4}$ " holes as well as the $\frac{1}{4}$ " holes) before any cutting is done.

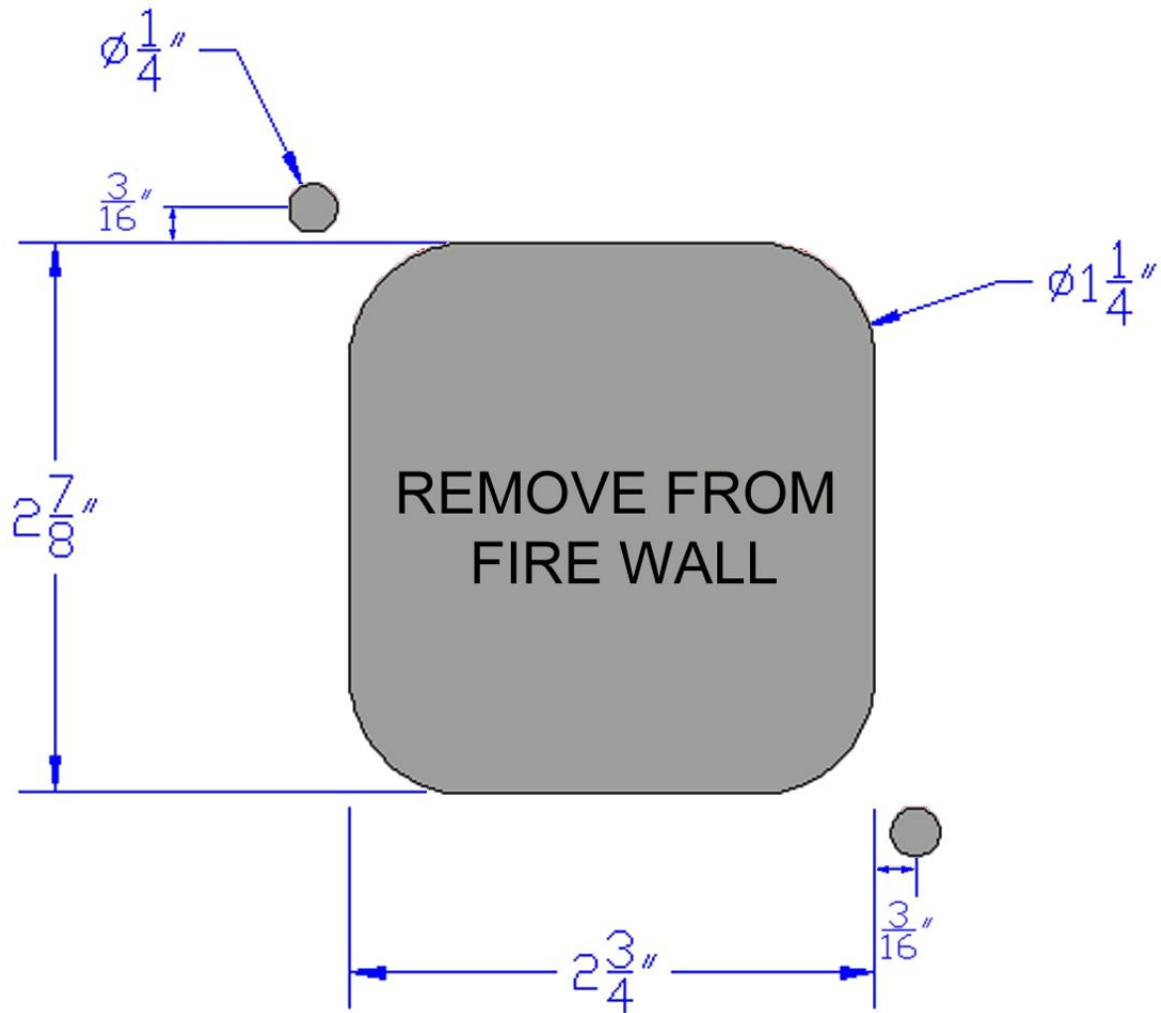

NOTE: This drawing MAY NOT be to scale, please double check your measurements with those on the drawing before any cutting or drilling.

Painless Performance Products LLC
2501 Ludelle Street
Fort Worth, TX 76105
Phone (817) 244-6212